

Interpretation of the itineraries of Central European Cup races

Table of content:

General information	4
1. Route.....	5
2. MAP.....	6
3. Route planning on the map	8
4. Navigation on the map.....	9
5. Navigation based on real information	10
6. Itiner window description.....	11
7. DETAIL	14
8. CONSTANT.....	15
9. CONDITION.....	16
10. INSERT	17
11. SM	18
12. SECTION	19
13. Delays and penalties	20
14. Examples	21
14.1. Basics – navigation on the map from map point to map point	22
14.2. Roundabout direction; drive in - out; navigation on the map from map point to map point....	28
14.3. Crosses and turns – navigation on the map from map point to map point	37
14.4. Objects on the map and other signs – navigation on the map from map point to map point... 44	44
14.5. Re-planning of the route – navigation on the map from map point to map point	49
14.6. Basics – navigation from real point to real point based on real information.....	56



14.7.	Others – navigation from real point to real point based on real information.....	61
14.8.	Navigation on the map from real point to map point	64
14.9.	Navigation based on real information from real point to map point	68
14.10.	Navigation based on real information from map point to map point	70
14.11.	Navigation based on real information from map point to real point	72
14.12.	DETAIL	75
14.13.	CONSTANT.....	77
14.14.	CONDITION.....	78
14.15.	INSERT	84
14.16.	SM	88



General information

These rules should be applied during all Central European Cup (CEC) races, no country specific rules are allowed except those rules which are illustrated by picture before race (examples without picture only with text even if translated to English is not allowed).

During CEC races you can go through on a ROUTE which described in the itiner with the help of MAPs and other instructions. These other instructions are: INSERT, CONDITION, CONSTANT, DETAIL and SM.

1. Route

The route is defining the next challenge with simple pictures.

Here you have an example:

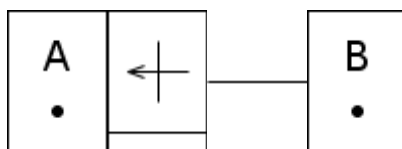

The information in the itiner picture (rectangle or window) means that: “do this” or “reach the mentioned point with the appropriate way”. The sign between the itiner pictures (or the missing sign between rectangles side by side) means that “drives towards” or “approach”.

There are two types of itiner pictures:

- **Based on map:** you should find the place on the map which described on the itiner picture. Sign: simple rectangle. See the example first itiner picture.
- **Based on real information:** you should find the place in the real world which described on the itiner picture without the map. Sign: Rectangle with a line at the bottom part. See the example second itiner picture.

The approach of a certain point could be two types as well:

- **Based on map:** you should find the way where you can approach that point on the defined map. Sign: link (line) between two itiner pictures. See the line between the second and third itiner pictures on the example.
- **Based on real information:** you should find the way without the map based on real information. Sign: two itiner pictures side by side without space. See the example between first and second itiner pictures).

2. MAP

You can find a part of real world on the map.

Example:

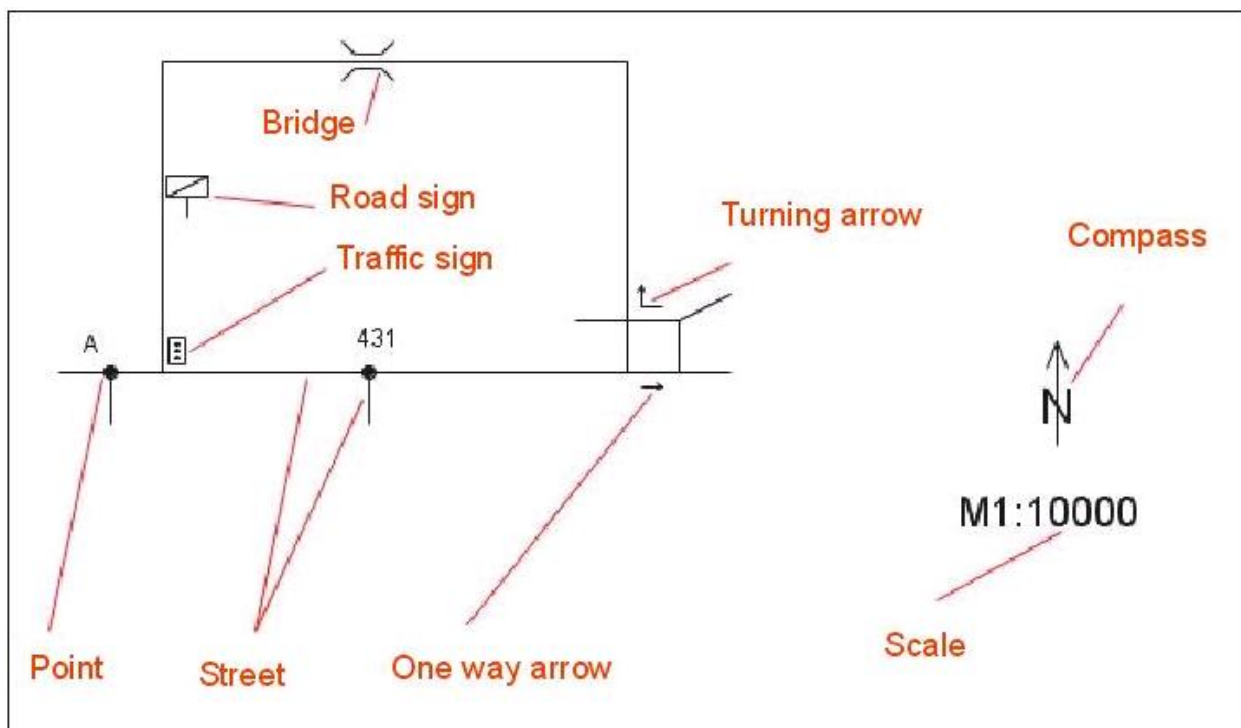

Parts of the map

- **COMPASS:** Mandatory part of the map. You can find one of the four main quarters on the map. The arrow points towards the mentioned direction, the character on the arrow means the first character of the English name of that certain quarter (N: North, S: South, W: West, E: East).
- **SCALE:** Also a mandatory part of the map. Usually it is in M1:xxxxx format which means 1mm on the map means xxxxx mm in the real world.

On our examples it is 1:10000 which means 1mm on the map = 10m in the real world.



Sometimes short version is also in use: $M10 = M1:10000$, $M20 = M1:20000$, $M25 = M1:25000$, $M50 = M1:50000$, etc.

On the example you can find two points: "A" and "431".

- **STREET**: On the map most of the lines are representing streets. Most of the streets on the map are representing a street in the real as well but not in every case (detailed explanation later). Please keep in mind that not all the streets should be visible on the map. If the itiner said that you should navigate based on map then you should plan your route based on those streets which are visible on the map. On the map those "sticks" are also representing streets which assign to street with only one side.
- **POINT**: Named location of the map. Small black circle with the name, it could be a number or character.

Later you can find named POINT in the text with capital letters.

- **ONE WAY ARROW**: If there is a "one way arrow" on the map it means that that street is a one way street based on map information (it's not necessary to have one way street in the real either!). This one way section is reasonable only between two crosses. When we are travelling based on map information then we should go through on this section as indicated by one way arrow.

On the example the street east from point 431 only a small section is indicated as one way street, so we can go through on that section only from west to east direction but on the other parts of that road we can travel as we want.

- **TURNING ARROW**: It's connecting to the cross (not for part of the street as one way arrow), so it's drawn next to the cross on the map, not between two crosses. Meaning of turning arrow: when we arrive to the cross from the leg of the arrow then we must move towards that street which pointed by the arrow but if we arrive from any other direction then turning arrow is not relevant for us, so we can travel as we want. It's similar than "compulsory heading" road sign.

On the example if you arrive from the East to that cross then you must turn to the North.

In some cases turning arrow mystify you because it would sign that you should move forward in a cross (e.g. from South to North). In this case the leg of the arrow is straight and for first sight you don't know that it will be a turning arrow.

If you have a more complex cross (e.g. delta cross) then turning arrow could overlap more crosses.

- **BRIDGE, ROAD SIGN, TRAFFIC SIGNAL**: Several objects should be marked on the map as well. As in case of streets those shouldn't be available objects in the real world as well.

3. Route planning on the map

If you need to find a way on the map between two itiner pictures (or from the actual position of the car) to a certain point or to a certain cross or to a certain object then you should follow the rules below:

- You cannot plan route which is turning around in the street.
- You cannot pass the street in that direction where you have arrived.
- The planned route cannot go through points which marked with characters or one or two numeral digits (see examples 1/7, 1/8).
- Your planned route should be in harmony with turning and one way arrows (see examples 1/3, 1/4, 1/5, 1/6).
- Your planned route should be in harmony with CONDITIONS (if any).
- Among available planned routes you should choose the shortest one (that is the shortest route which length is at least 20% shorter than the second one or you can choose the shortest route based on basic geometric rules) (see examples 1/1, 1/2).
- If you should go from one point to the same point and you can find two ways with the similar length then you should use plan your route according to the roundabout direction (see examples 2/1, 2/2, 2/3).

If we should plan a route to a dedicated cross (instead of certain point) or a dedicated object then you should choose the nearest of those ones (you should plan your route to the nearest object/cross on the map not on the air).

4. Navigation on the map

After you planned your route on the map you should going through on the planned route. Sometimes it is not possible because you should re-plan your route according to the actual road signs or traffic rules.

Possibilities are listed below:

- Road sign, continuous white line or other sign are not allow to go through on the planned route (see examples 5/1, 5/2, 5/6, 5/7).
- Checkpoint sign gives real information to you (e.g. turn around).
- Street marked on the map is not available in the real world (see examples 5/3, 5/2).

If any listed case occurred then you have two possibilities:

- You are on the street which is not marked on the map, you should drive according to the rules of navigation based on real information until you will be on a street or at the cross again which is listed on the map. In this case you should re-plan your route from the actual position of car. (see examples 5/6).
- Still you are on the street or at the cross which is marked on the map. In this case you should re-plan your route from the actual position of car and you should plan with those real information which is available for you at your current location (e.g. at the cross you can see the road signs, etc.) but those real information which collected earlier are not allowed to use during re-planning. (see examples 5/1, 5/2, 5/3, 5/4, 5/5, 5/7).

Sometimes the organizers are marked street on the map which not available in the real world. The most difficult thing is to recognize these “not available” streets. It is possible to have a similar street in that area but real distance from the cross and measured distance on the map are different. How we can decide that is only a measurement error or a “not available” street? The solution is simple just draw the street to the map according to the measures. If the distance between the original street and our drawn street is smaller than 5mm then it should be a measurement failure. (This is 50m differences in M10 scale, 125m in M25, etc.) If street is starts from the right point but not in the marked direction than we should talk about measurement error only that case if the differences between real and marked direction is smaller than 20°.

5. Navigation based on real information

If you should move to a certain place according to real information without map then you should follow the rules below:

- If driving is straightforward because road signs are allow only one way then you should go there (e.g. “compulsory heading” or “no entry” sign).
- We are travelling on the street until we have notice that we are at the proper cross.
- When we are travelling on main road and arrive to a cross (road sign is indicate the continuation of main road) then we should follow the main road.
- Every other case we should move straightforward.

(See 6. Example)

If we cannot continue our route based on previous rules because we have arrive from minor road to a cross where no road straightforward then we are on wrong route.

During navigation based on real information you don't need to turn around except special sign instruct you for this action (e.g. checkpoint sign).

6. Itiner window description

There should be six combinations of itiner pictures:

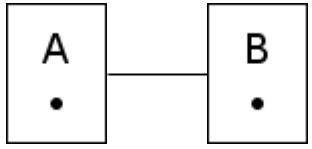
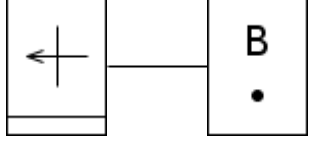
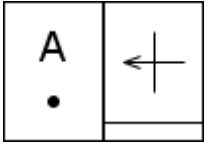
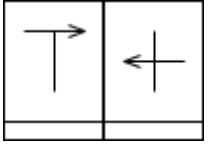
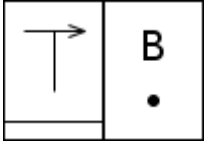
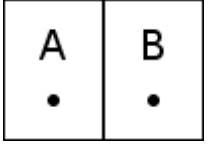

Name:	Sign:	Description:
navigation on the map from map point to map point		From POINT A to POINT B we plan a route on the map and drive according to the rules of navigation on the map and our planned route. If there is a number or character on the line between two itiner pictures then you should plan your route on that map which indicated by that number or character (see 1, 2, 3, 4, 5. Example).
navigation on the map from real point to map point		When we turned left at the (full-) cross we should plan a route in the map to POINT B and drive according to the plan (see 8. Example).
navigation based on real information from map point to real point		When we arrived on the map to POINT A we should travel according to the rules of navigation based on real information until we will be in a full-cross and we should turn left there (see 11. Example).
navigation based on real information from real point to real point		When we have turned right at the T-cross we should travel according to the rules of navigation based on real information until we will be in a full-cross and we should turn left there (see 6, 7. Example).
navigation based on real information from real point to map point		When we have turned right at the T-cross we should travel according to the rules of navigation based on real information until we will be in POINT B on the map (see 9. Example).
navigation based on real information from map point to map point		When we have arrived to POINT A on the map we should travel according to the rules of navigation based on real information until we will be in POINT B on the map (see 10. Example).

What may have in the itiner picture?

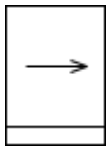
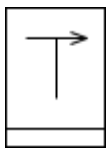
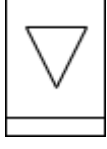
Itiner pictures in real may have:

Name:	Sign:	Description:
direction statement		At the next cross where you have possibility you should move forward according to the stated direction (left, right or straightforward). It is independent from the type of the cross. If you have more crosses at the stated direction you should choose the nearest one from that direction where you have arrived to the cross.
real cross type		If you drive according to this information then you should find a cross which has the same type as stated on the picture (T-cross in this case). You will arrive to the cross from the bottom side of the picture (except if a full spot indicate the arrival direction) and turn towards the arrow.
object		You should drive until you will find the stated object (e.g. if you need to find a bridge then you should go through on that, if it's a road sign then you should pass the road sign).

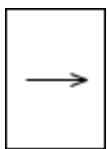
Itiner pictures on the map may have:

Name:	Sign:	Description:
direction statement		At the nearest cross on the map where you have possibility you should move forward according to the stated direction (left, right or straightforward). Those crosses where you have mandatory leaving direction (e.g. turning arrow) are not counted as cross.
cross type on the map		At the nearest cross which has the same type on the map and you has possibility you should move forward according to the stated direction. There is a possibility to define the arrival or leaving direction if those are not defined then we can choose as we want (of course we should plan according to the rules of navigation on the map).

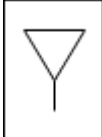
POINT on the map		We should arrive to the mentioned POINT from the stated direction, similar as arrival to the cross.
object on the map		We should arrive to the nearest object on the map and pass that.

7. DETAIL

Detail is an enlarged piece of the map. Most of the cases it is describe a more complex cross and its surroundings. All the signs on the detail are valid for all the maps. At least one common POINT must be available between detail and map to fit map with detail. If no other scale then detail is in M1:10000 scale (see 12. Example). All the roads must be noted on the detail which is under the detail area. All connection roads must be visible in case of each cross on the detail.

8. CONSTANT

Constants are general rules which available for the whole etap. Most of the cases constants are defining road sign in proper way (see 13. Example). Rotation order (or roundabout direction) is also a special constant.

9. CONDITION

Condition is define a term which should be keep in mind when you are planning your route on the map (See 14. Example).

There are several types of conditions:

- **Referring to certain map POINT:** when we arrive the POINT on the map we should go according to the stated rule (see examples 14/1, 14/2).
- **Referring to sign on the map:** when we pass that stated sign on the map we should execute the provided commands (see examples 14/3).
- **Referring to a certain part of the itiner:** Between two itiner picture during the route we should travel according to provided rules (see examples 14/4, 14/5, 14/6).

Example:

CONDITION:

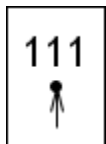

In this case we should arrive to POINT 111 only from South.

It is very important to know that you should use CONDITION information only when you are travelling according to the map.

10. INSERT

Insert is a special instruction which should be added to the route before finishing the actual route. Insert all the time defines that WHEN and WHAT should be added to the route. WHEN should be arrival to a certain point, pass a certain road sign, reach certain distance or other thing. Most of the cases the WHEN is answered in the itiner picture. When we have executed the insert command we can move forward according to our original plan (see 15. Example).

Big difference between CONDITION and INSERT is that we should plan our route based on CONDITION information but we cannot plan with INSERT, because we will realize the INSERT information only when we are travelling during that section where we should add INSERT to our route.

Example:

INSERT:

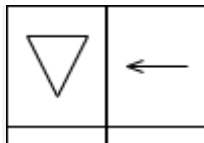

In this case when we arrive to the mentioned road sign we should turn left at the first possibility (most of the cases it is the cross at the road sign but not in all cases).

11. SM

SM is defining a route with graphic way where we should going through on the stated direction. SM is independent from the maps, so we should bypass the signs of maps. Some cases during SM section we should travel on those streets which are not marked on the map.

At least three basic data belongs to SM: scale, compass and one POINT on the map to fit SM to the map. In some cases arrival and leaving direction are also define on the SM with an arrow or at the end of the SM with real itiner picture.

SM starts and ends at cross where leaving direction is not mandatory direction. Sometimes we should interrupt our travel on SM (e.g. because of INSERT or road sign). In this case we should continue the SM from that point where we have interrupted our route.

Rules of arrive back to the interruption:

- It is not allowed to drive on the route of SM.
- It is not allowed to drive against the SM direction.
- It is allowed to cross the SM route.
- You must plan your route back to the interruption point on BASE MAP.

(See 16. Example).

12. SECTION

In some cases CONDITION or INSERT is valid only for a certain part of the route not for the whole route. So, we should drive according to the mentioned rules on a certain part of the etap but during the rest of the etap we should bypass those rules.

Example:

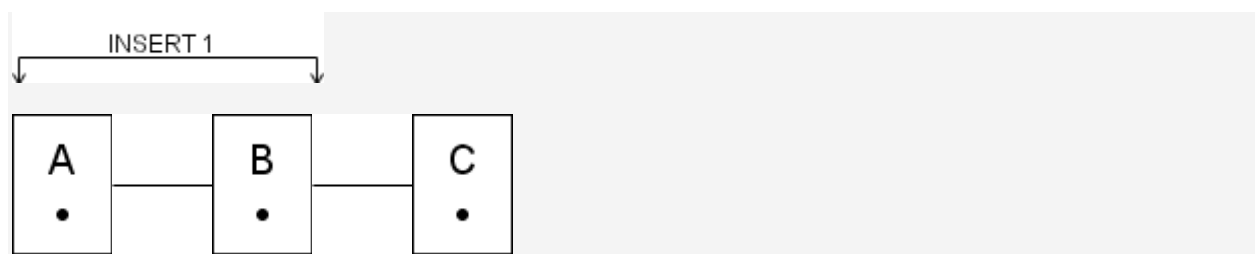

In this example we should drive according to INSERT1 rule from POINT A to POINT B. When we arrived POINT B we should drive without INSERT1 rule.

13. Delays and penalties

Delays:

One stage – maximum delay – 45 minutes.

Two stages – maximum delay – 60 minutes (maximum delay is 45 minutes per etap).

From three stages – maximum delay – 90 minutes (maximum delay is 45 minutes per etap).

Penalties:

1 – 10 minutes - every minute is 5 points

11 – 20 minutes - every minute is 10 points

21 – 30 minutes - every minute is 15 points

31 – 60 minutes - every minute is 20 points

from 61 minutes - disqualification

During technical race:

1 second = 2 points,

1 failure = 10 points

Penalties during stages:

plus check point = 60 points

minus check point = 100 point

radar = 10 points / 1km/h over speed limit

14. Examples

During examples the green line means the correct route the red one means the incorrect route. On the maps you can find North direction towards the upper edge of the map.

14.1. Basics – navigation on the map from map point to map point

During this example you should plan a route between two map POINTS.

The itiner is:

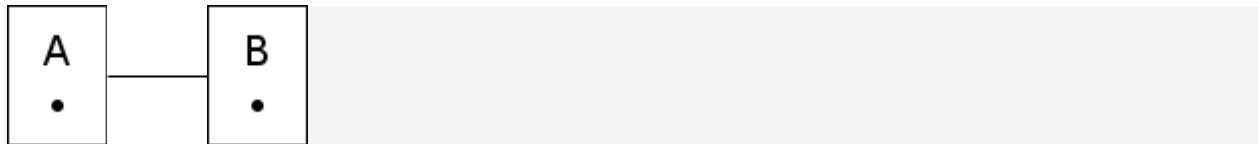

1. Example:

Map is:

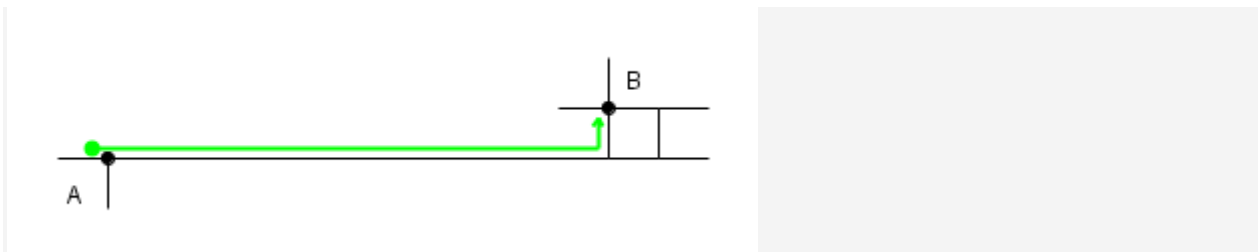

This is a very simple situation: From point A you can choose the shortest route to point B based on geometric rules: one side of the square is shorter than the other three together, so you don't need to go round of the square.

2. Example:

Map is:

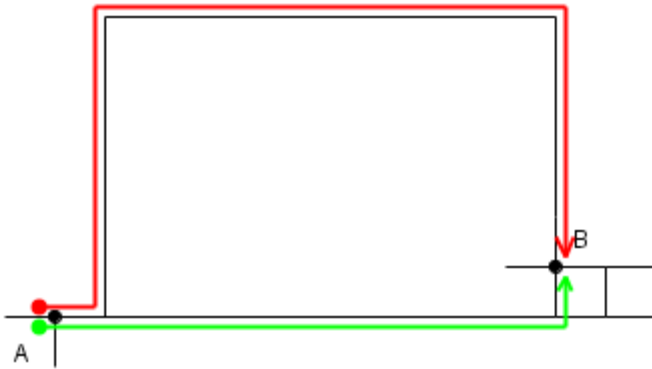

In this case you can choose between more routes but when you measure the possibilities you will see that the red one is longer than the green one.

3. Example:

Map is:

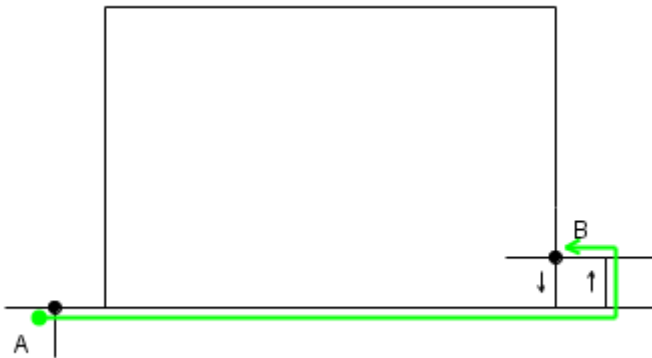

You can see the usage of one way streets (one way arrows) in this example. You cannot plan a route which going against one way arrow.

4. Example:

Map is:

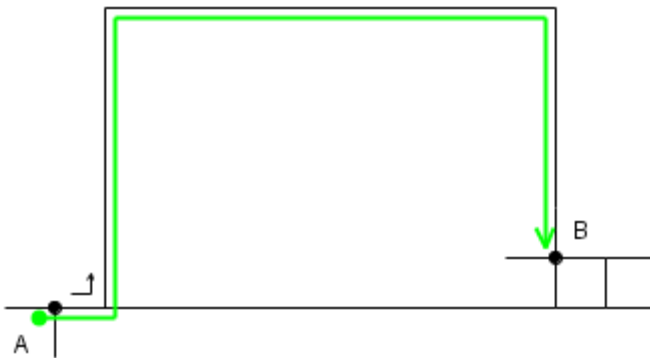

You can see the usage of turning arrow in this example. You have no any other possibility only the green one.

5. Example:

Map is:

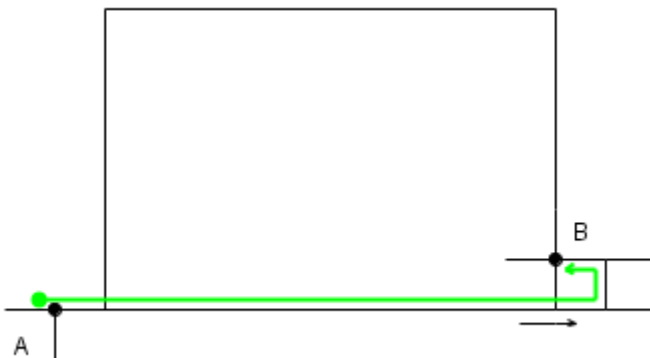

You have more possibilities in this example but together with turning arrow (which in this case means that you should move straightforward in that cross) the marked route is the shortest one.

6. Example:

Map is:

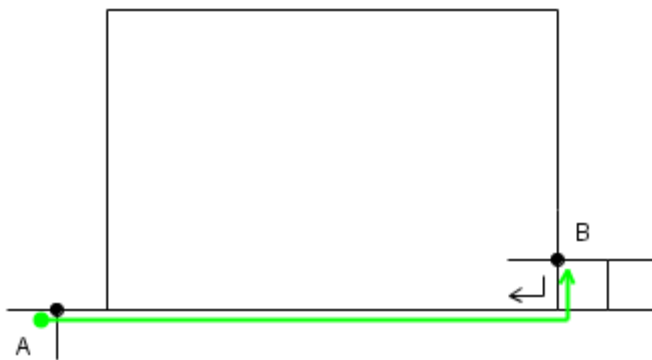

You can drive according to the turning arrow if you arrive from the leg of the arrow, otherwise you can turn as you wants.

7. Example:

Map is:

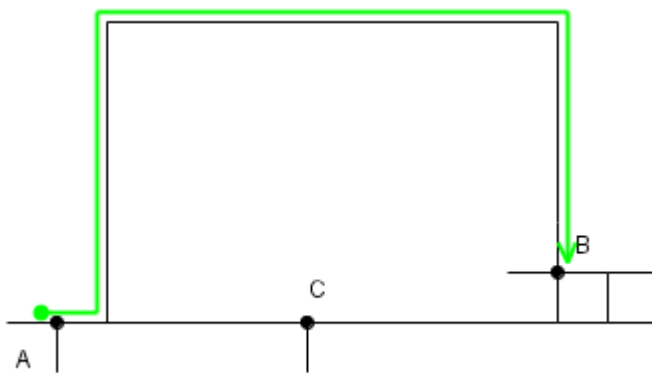

You cannot plan a route through POINT C if it is not specified in the itiner.

8. Example:

Map is:

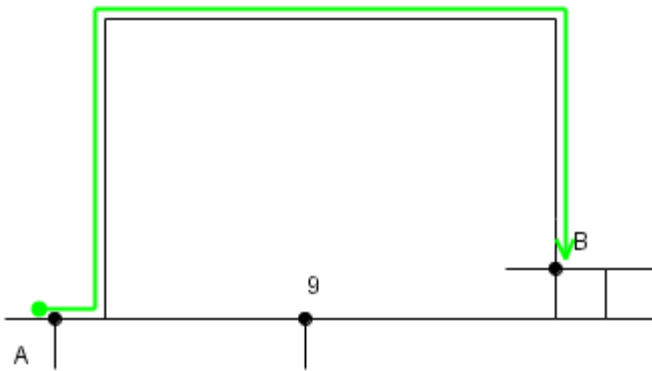

The same rule should be applied in case of one or two numeral digits as well.

9. Example:

Map is:

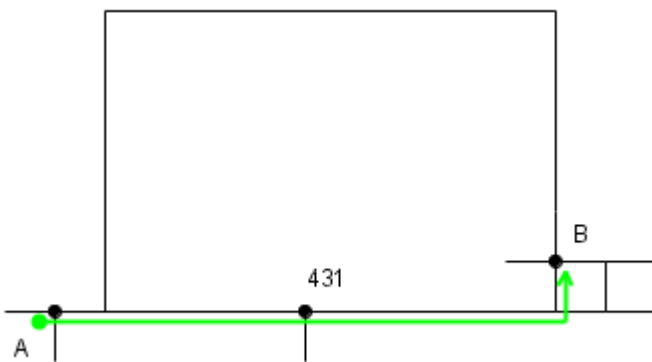

You can plan a route through POINT which marked with three numeral digits.

10. Example:

Street below a bridge on the map:

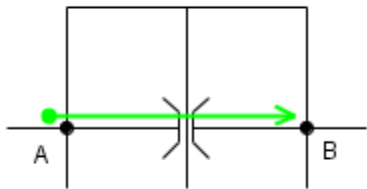

When the streets on the map are attached to the sides of the bridge then you should consider that street as a continuous street. It means that in the example you can plan the shortest route on the map from POINT A to POINT B under the bridge.

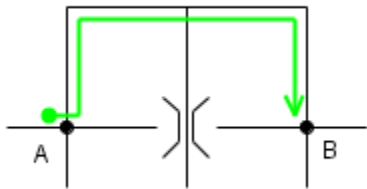

When the streets on the map are not attached to the bridge it means two independent streets on the map, so you cannot plan a route from POINT A to POINT B on the map below that bridge.

14.2. Roundabout direction; drive in - out; navigation on the map from map point to map point

1. Example:

We will show the usage of “roundabout direction” (or rotation order).

The itiner is:

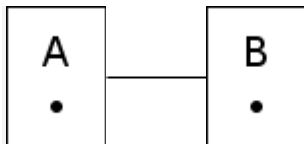

Roundabout direction is:



It means that you should plan a route on the map from POINT A to POINT B and if you can find two routes which has the same length then you should drive according to the roundabout direction.

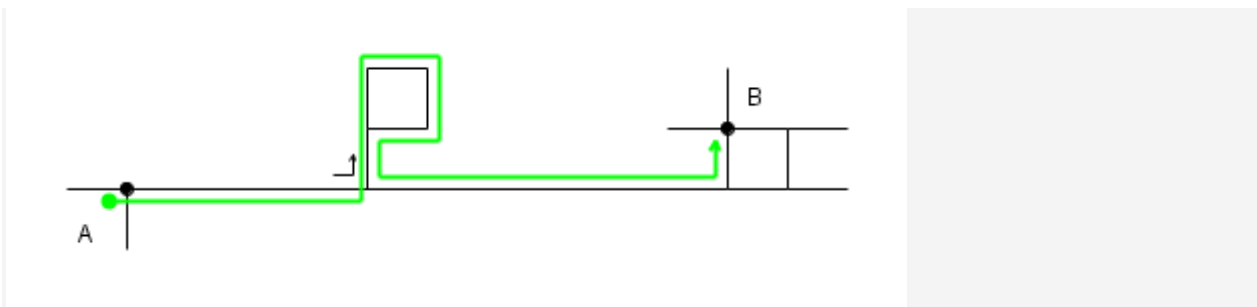

2. Example:

Other example for roundabout direction usage:



Roundabout direction is:

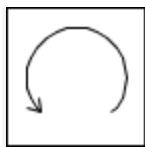

Correct route is:

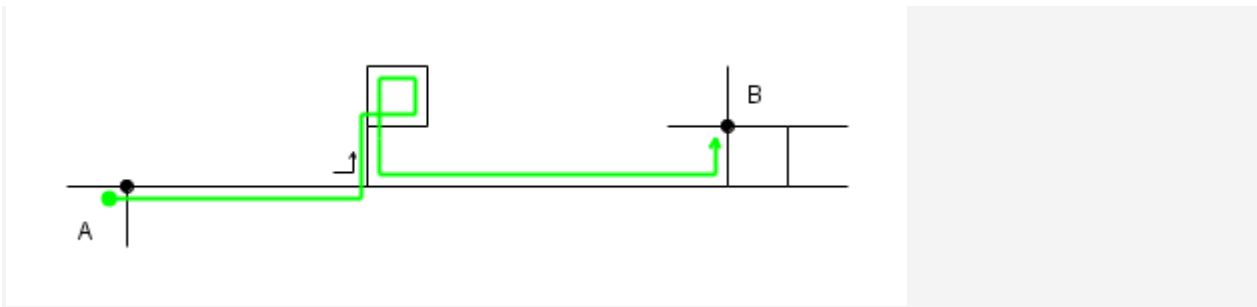

3. Example:

You should plan a route on the map from POINT A to POINT A according to the roundabout direction:

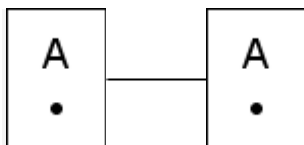

Roundabout direction is:

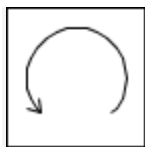

Map is:

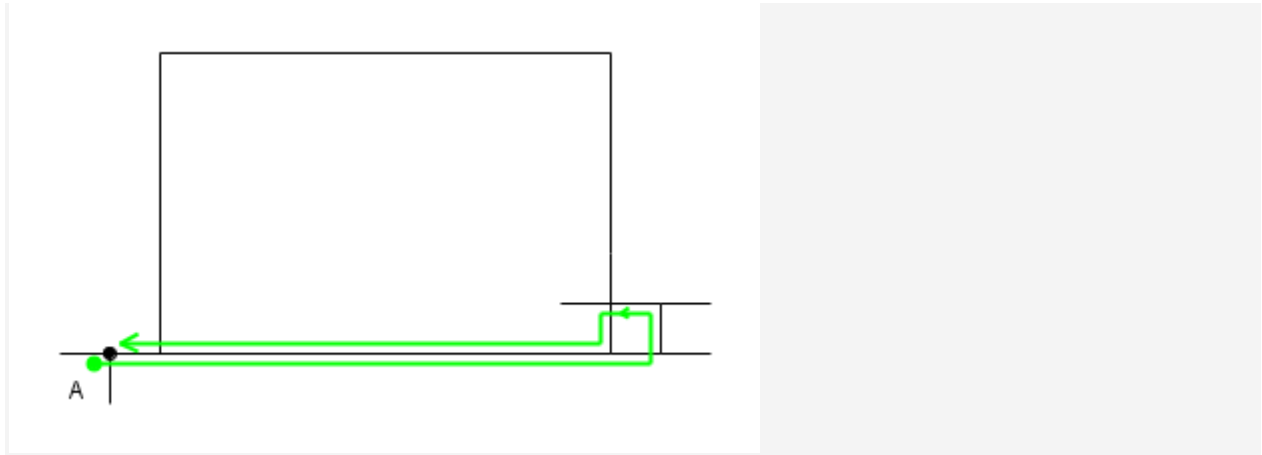

We should plan the shortest route on the map from POINT A to POINT A but we should plan according to the roundabout direction.

4. Example:

It is a simple but longer example:

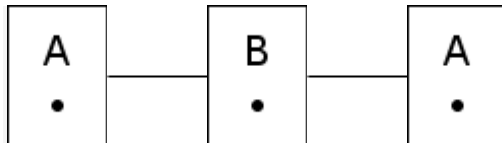

Roundabout direction is:

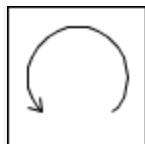

Map is:

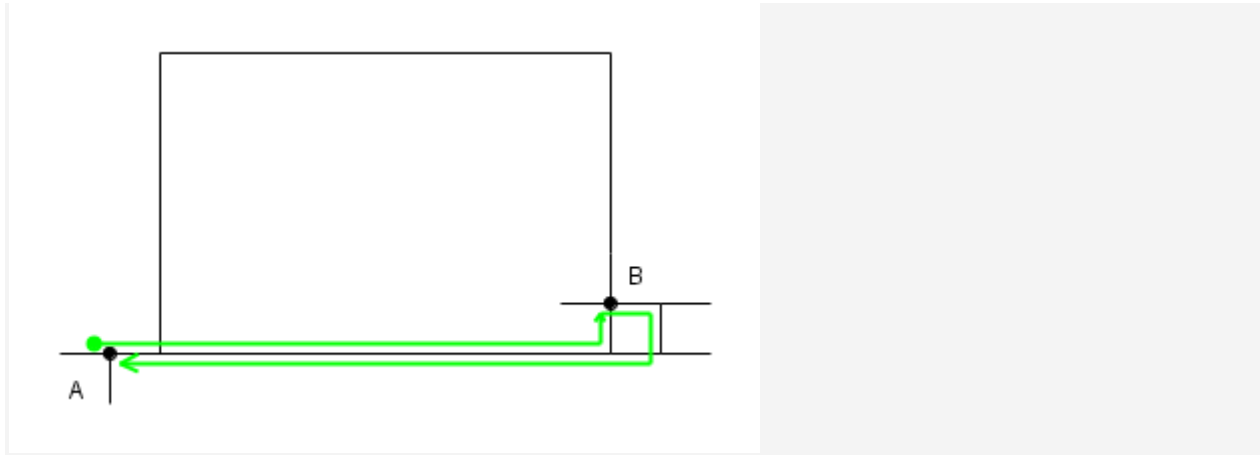

We should plan the shortest route from POINT A to POINT B and after that starts to plan a route to POINT A again. That's the reason why we don't need to pay attention to the roundabout direction. If we plan our route according to the roundabout direction then the planned route from POINT A to POINT B would be longer than in the mentioned case.

5. Example:

This is an example of arrival direction:

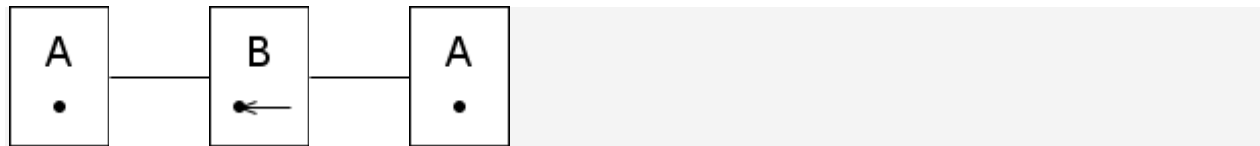

Map is:

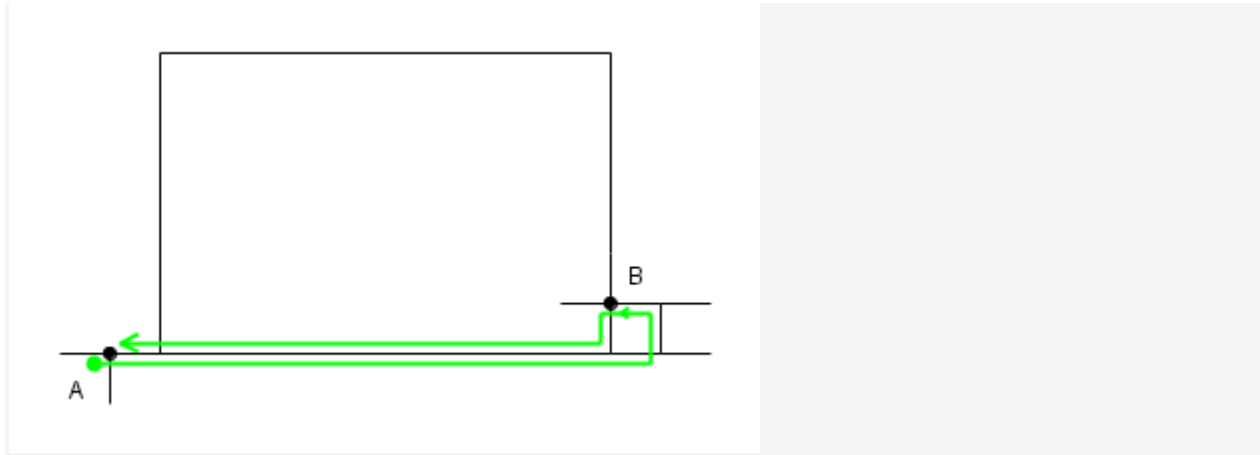

We should plan a route on the map where we can arrive to POINT B from East. After that we should plan a route on the map to POINT A.

6. Example:

This is an example of departure direction:

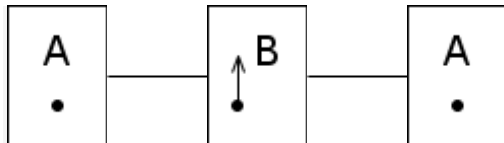

Map is:

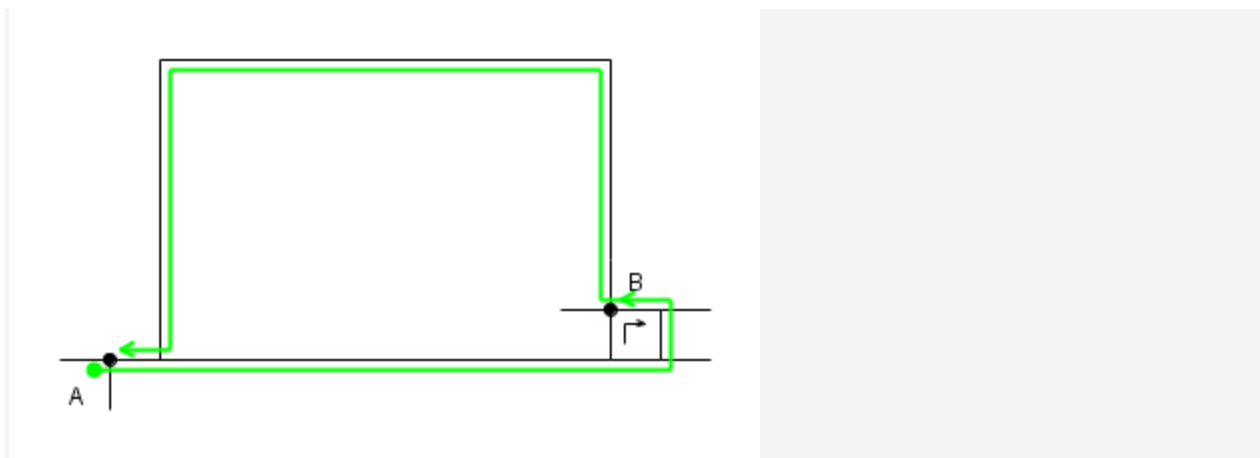

We should plan a route on the map to POINT B what should be departure towards North. When we left POINT B to North we should plan the shortest route to POINT A.

7. Example:

Arrival and departure directions together:

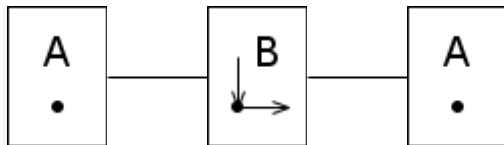

Map is:

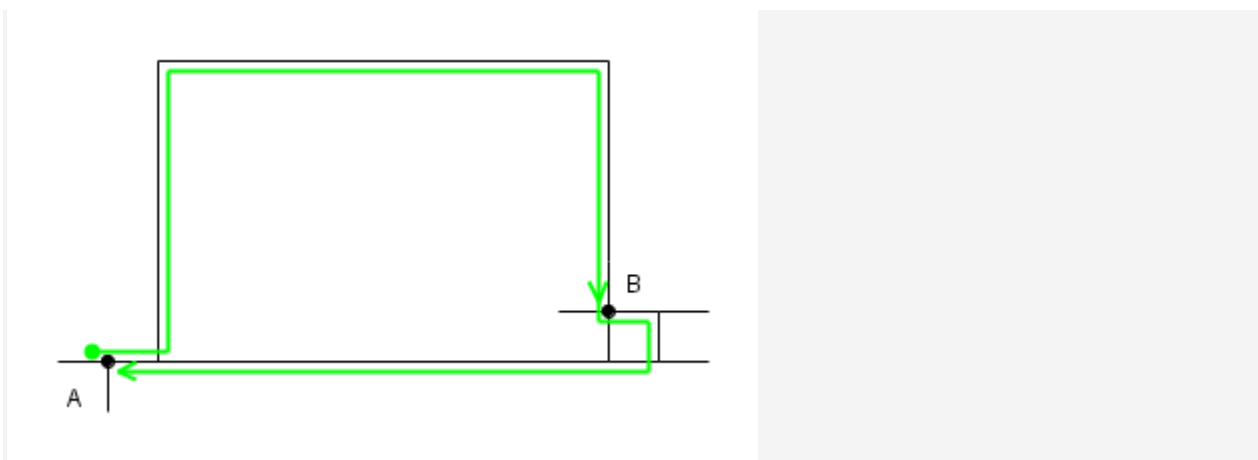

We should plan a route on the map to POINT B what fulfill the following requirements: we should arrive from North and departure to East. After that we should find the shortest route to POINT A.

8. Example:

Arrival and departure directions in separate itiner pictures:

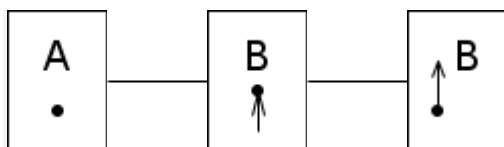

Map is:

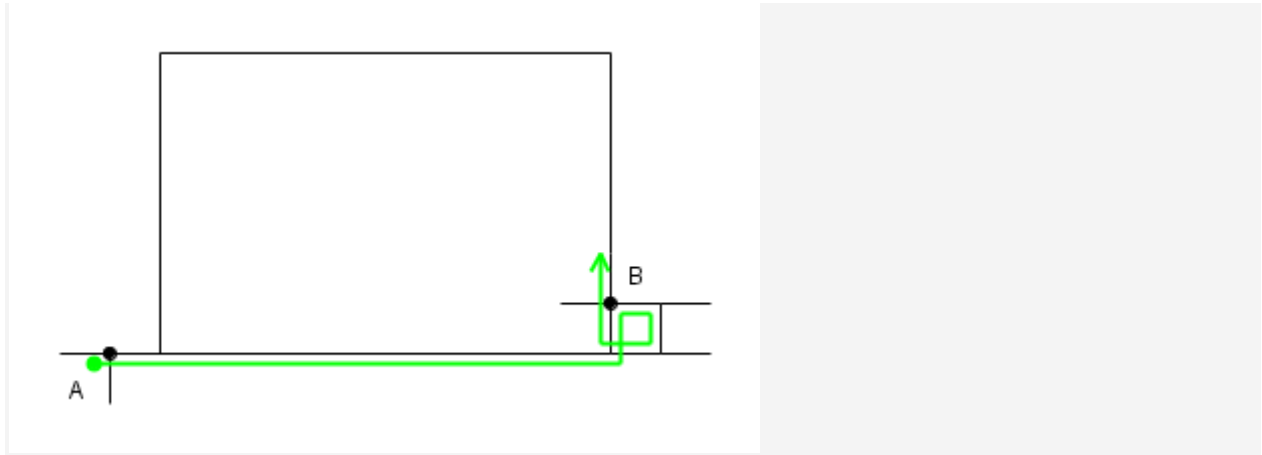

First we should arrive on the map to POINT B from South. After that we are able to leave POINT B to North but according to the itiner we should reach POINT B two times and we should travel on the map before we leave POINT B to North, so we should turn around in the square.

9. Example:

Similar than before without arrival and departure directions:

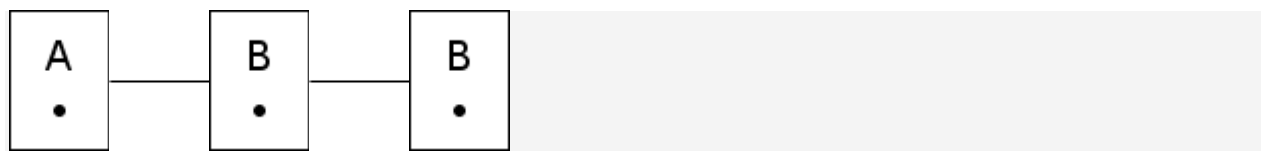

Map is:

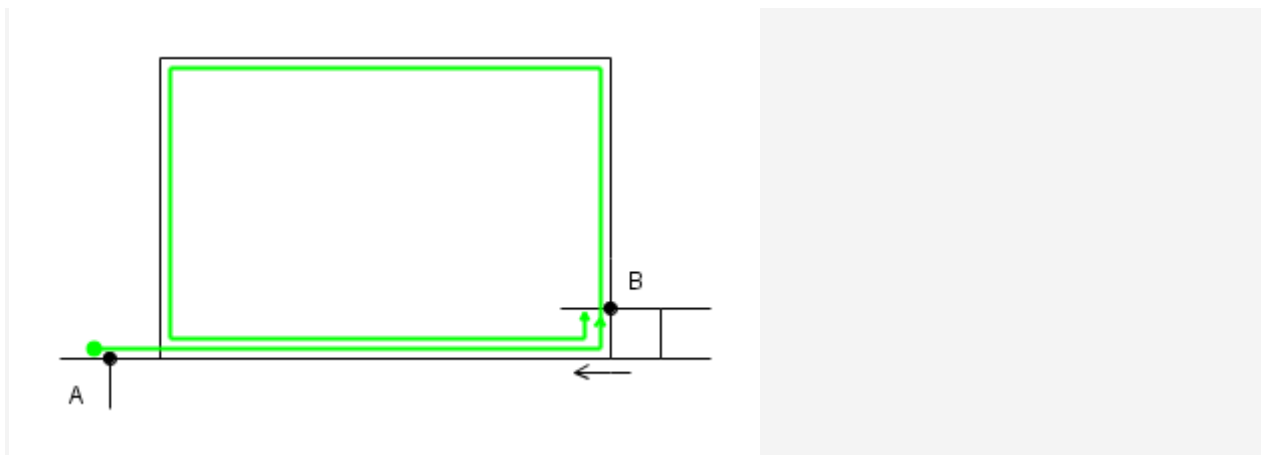

First we should reach POINT B on the shortest way after that we should find the shortest way to POINT B again.

10. Example:

Different challenge, we should reach POINT B two times.

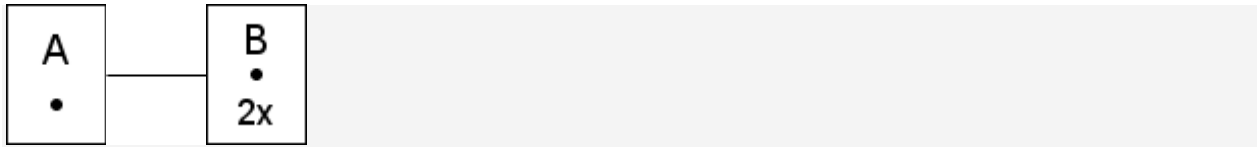

Map is:

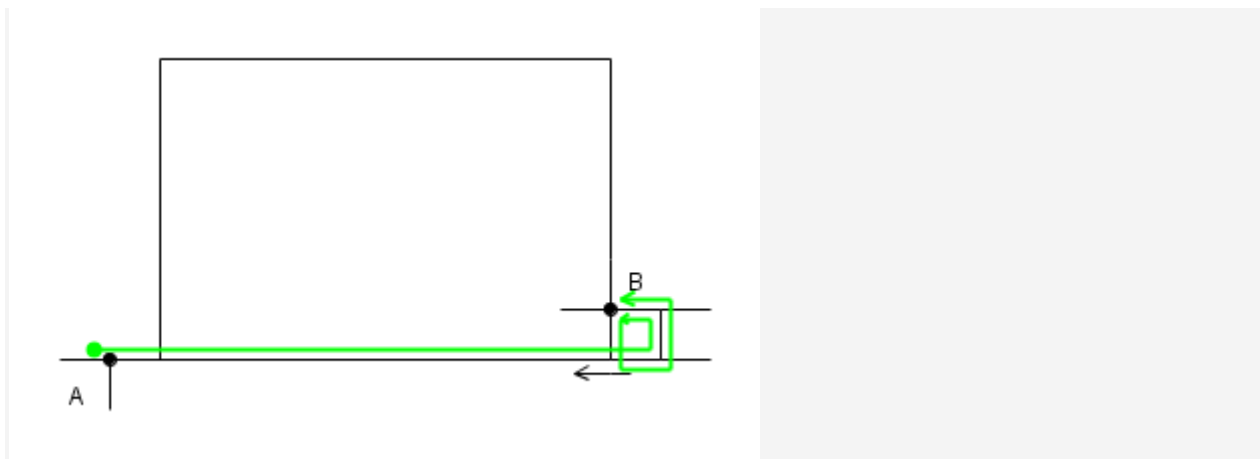

From POINT A we should find the shortest route which is reaching POINT B two times. It is different from previous examples because when we are planning our route to POINT B we already know our following route.

11. Example:

We should reach POINT B and departure straightforward on the map.

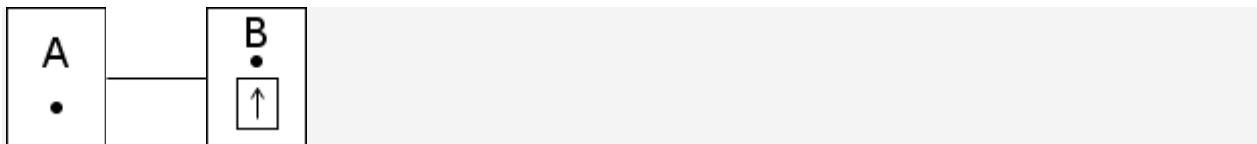

Map is:

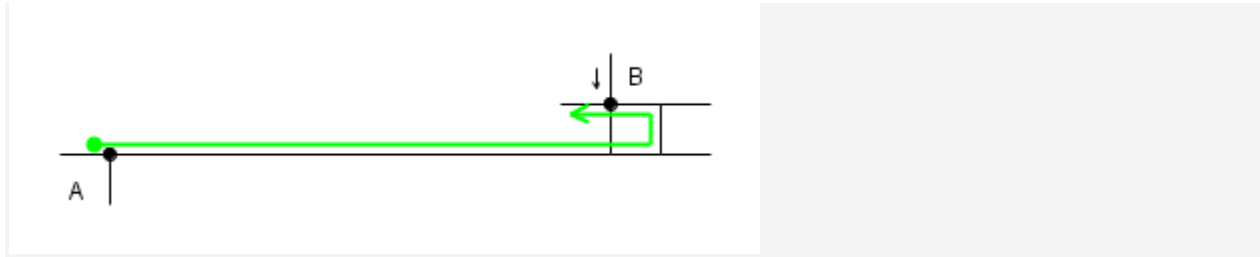

We cannot reach POINT B from South because then we won't be able to go straightforward on the map from POINT B. Based on this we should arrive from East (this is the shortest way) and we will be able to go straightforward on the map to West from POINT B.

12. Example:

We should reach POINT B on the map and departure straightforward based on real information.

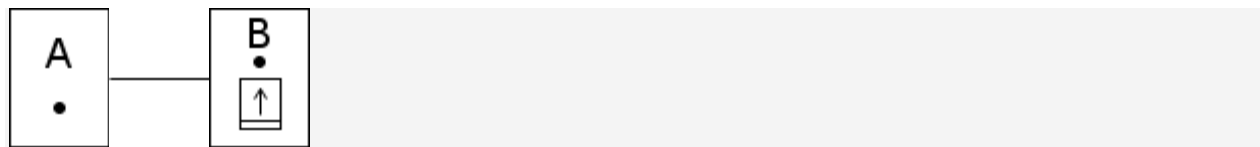

Map is:

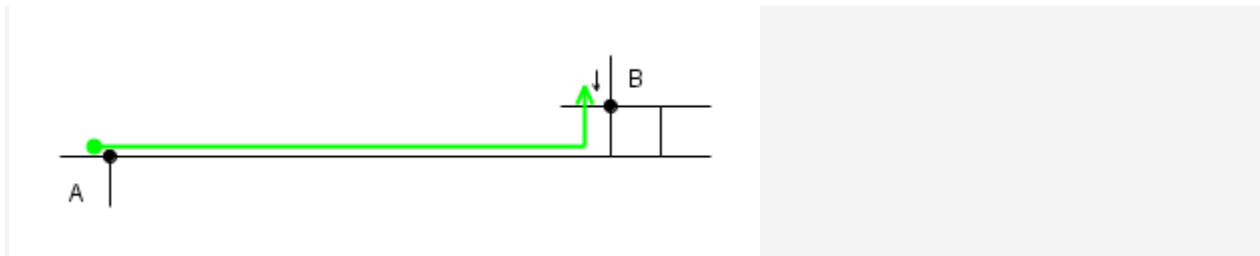

We cannot plan with real information when we plan our route on the map, so we can go to POINT B on the shortest way. When we have arrived to POINT B we will go straightforward based on real information, so we will leave that point to North based on real information, so that one way arrow on the map won't be relevant for me.

14.3. Crosses and turns – navigation on the map from map point to map point

1. Example:

Itiner:

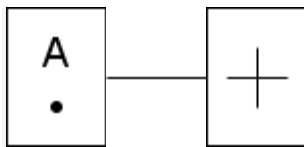

Map is:

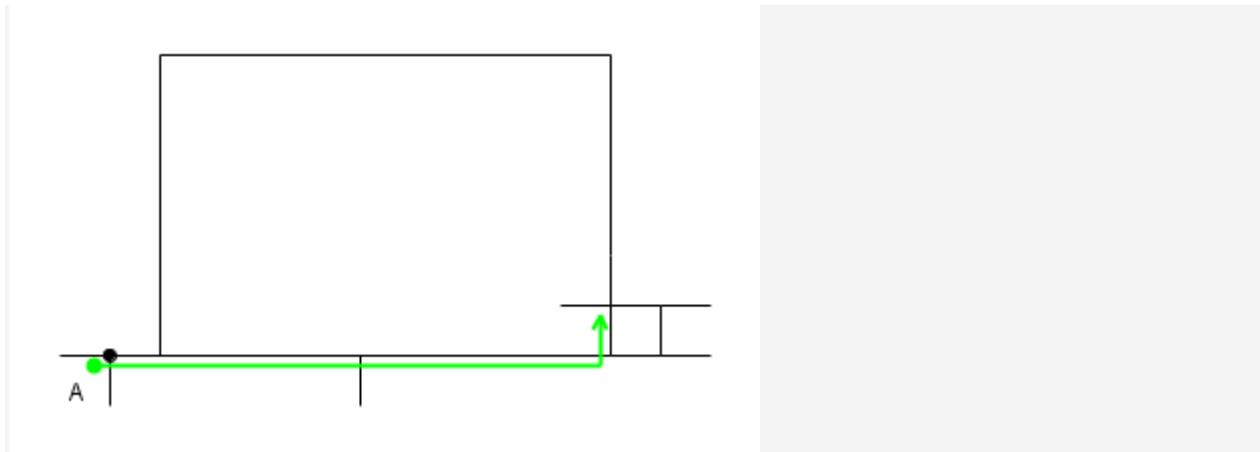

We should find the nearest full-cross which has the same type than indicated on the picture (consist of North-South and East-West crosses).

2. Example:

Itiner:

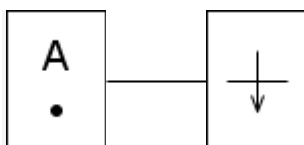

Map is:

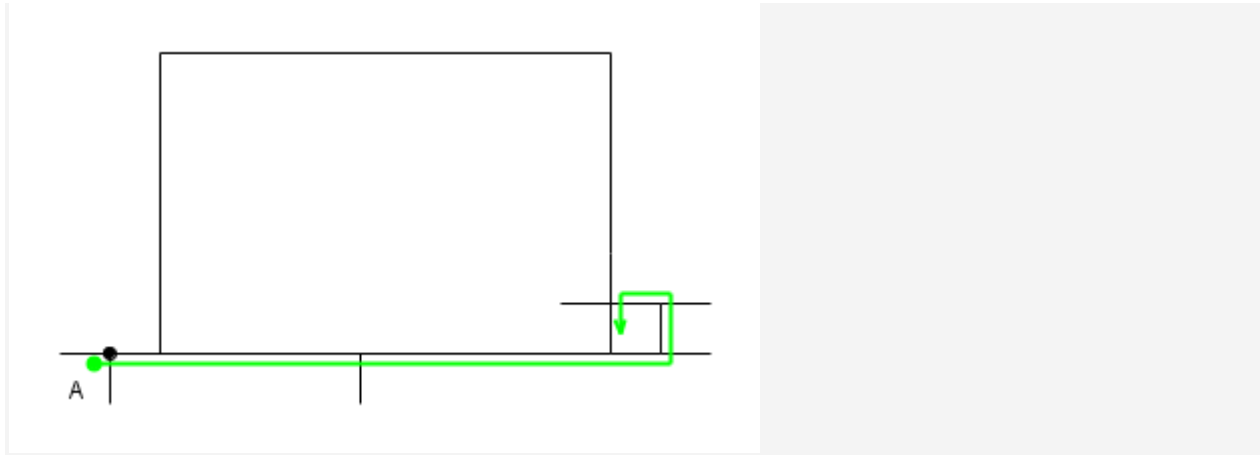

You should arrive to the full-cross on the map from that direction where you will be able to leave that to South.

3. Example:

Itiner:

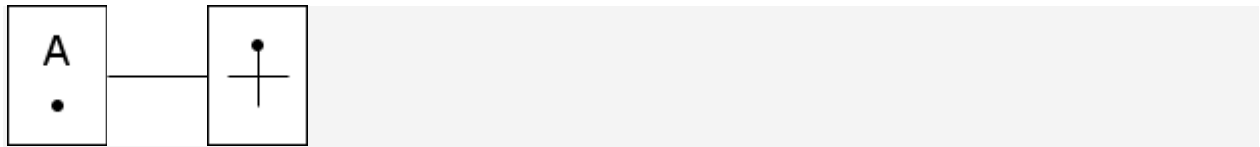

Map is:

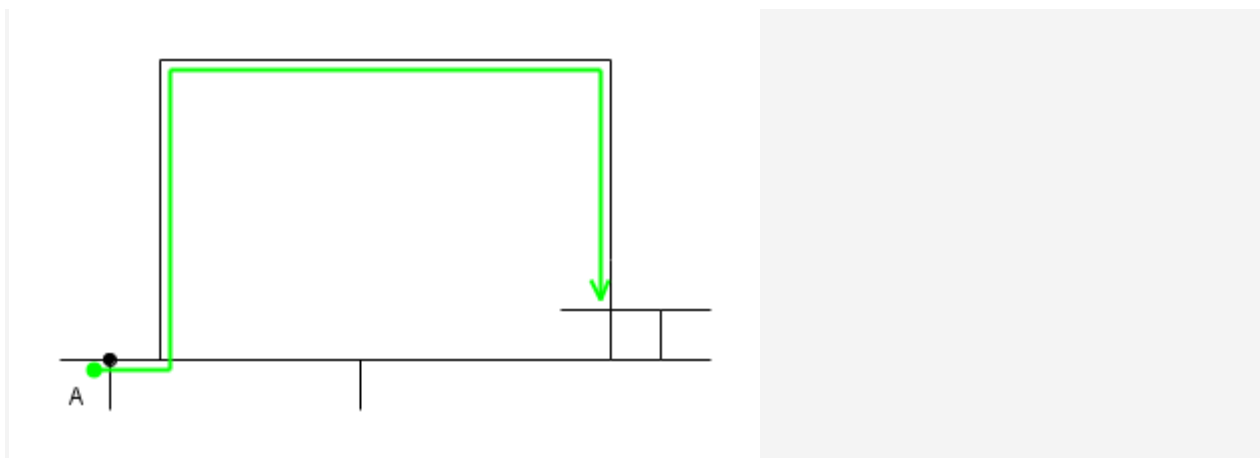

You should arrive from North to the full-cross on the map.

4. Example:

Itiner:

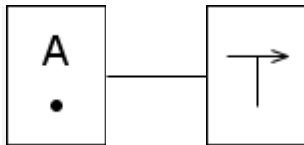

Map is:

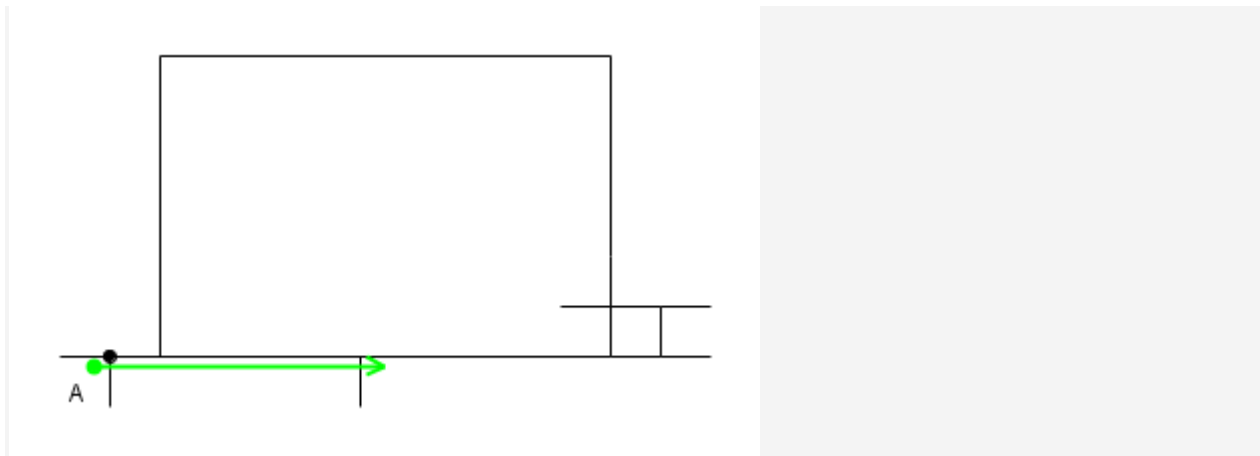

You should find the nearest T-cross on the map.

5. Example:

Itiner:

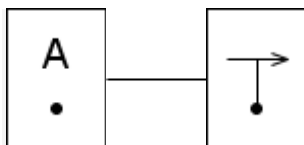

Map is:

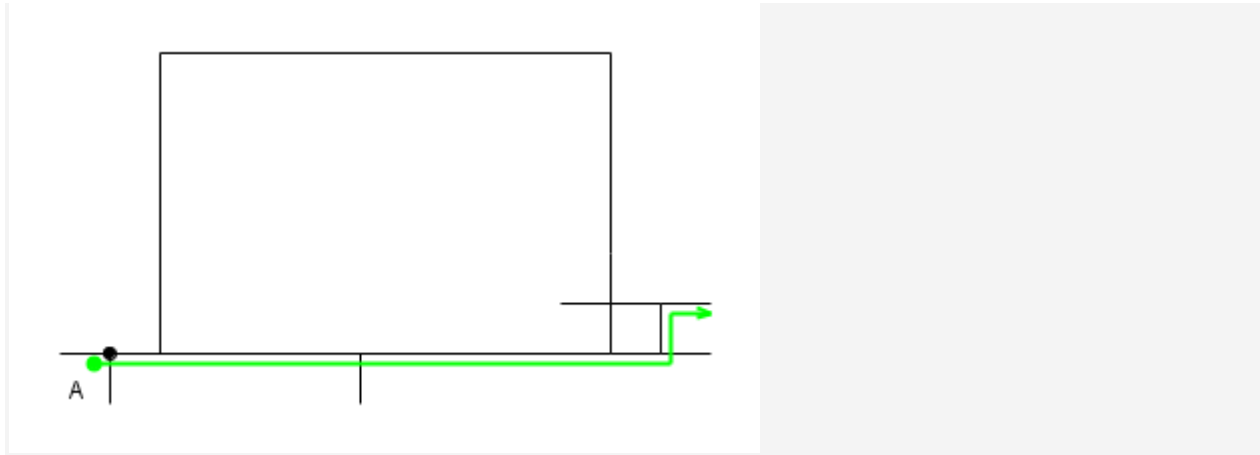

You should find the nearest T-cross on the map where it has streets towards East, West and South and you are able to reach that cross from South. When you are there you should leave that cross towards East.

6. Example:

Itiner:

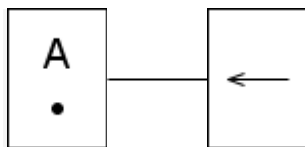

Map is:

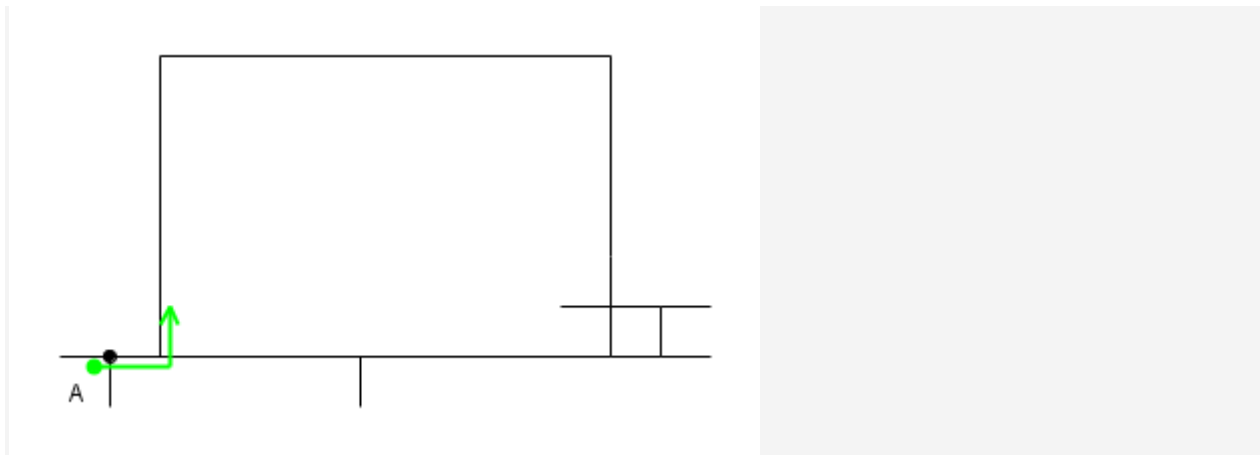

You should turn left at the nearest cross on the map where it is possible.

7. Example:

Itiner:

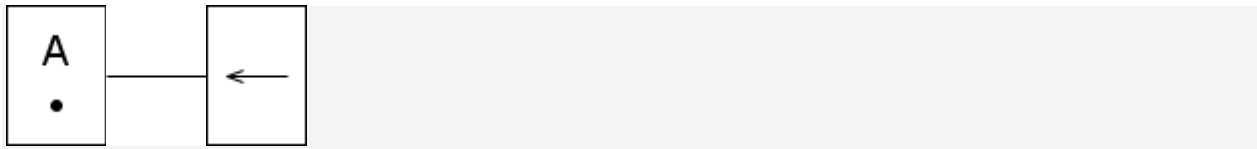

Map is:

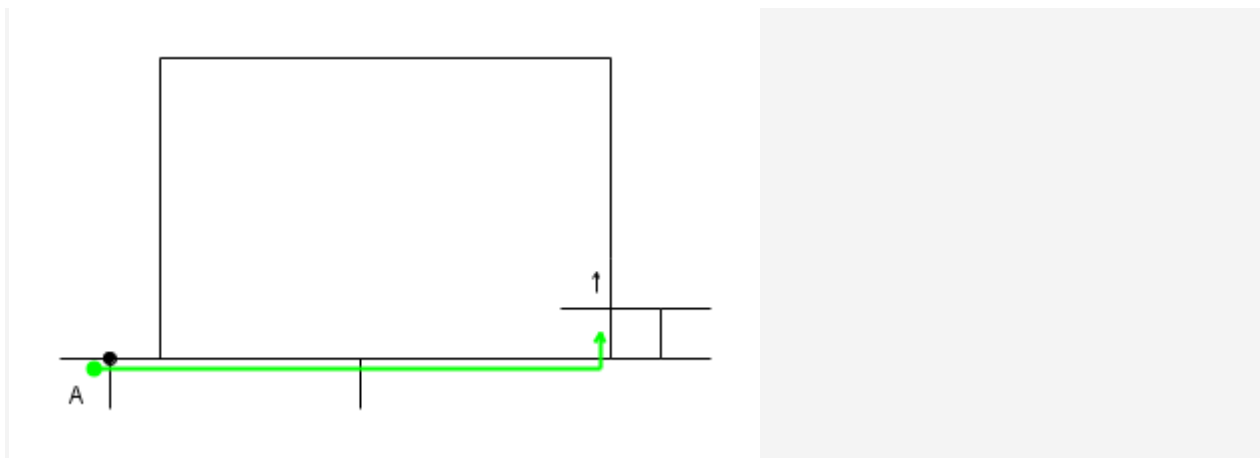

The first street on the map is one way street from the other side, so the first possibility where we can turn left is the cross below the full-cross.

8. Example:

Itiner:

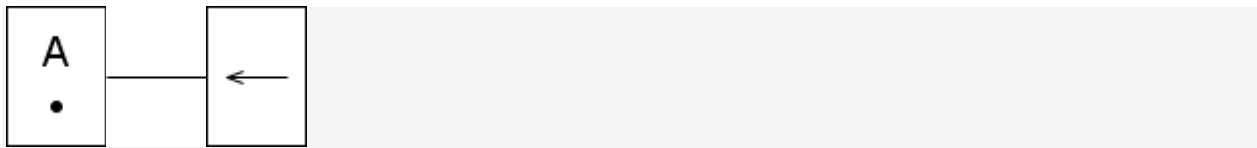

Map is:

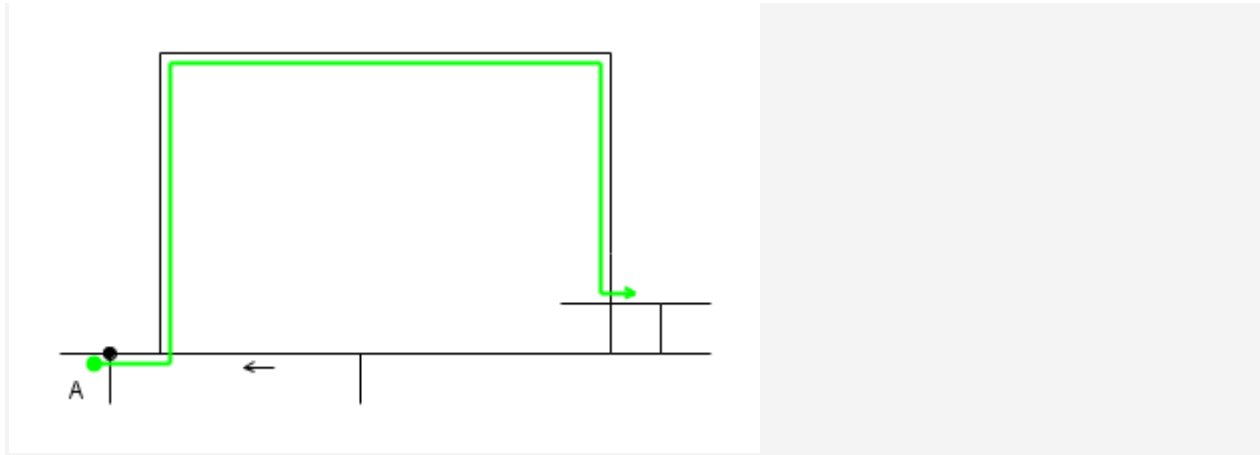

You cannot go straightforward at the first cross because of one way arrow, so that is not a real cross (because you cannot go other way than left), so you can turn left at the full-cross as nearest.

9. Example:

Itiner:

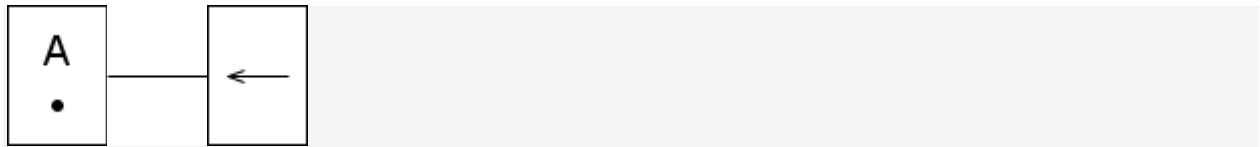

Map is:

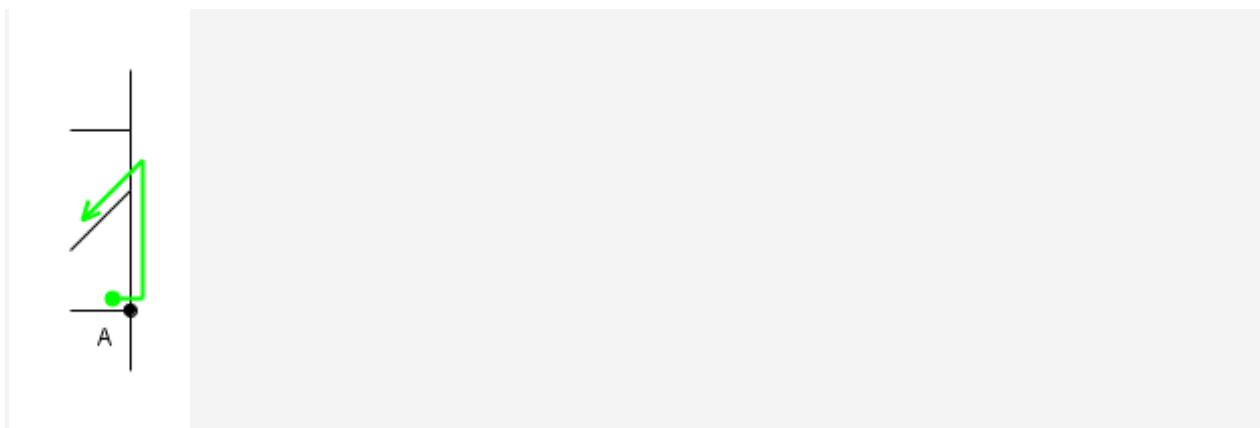

If the itiner just said that you should turn left then you can turn left at the nearest cross where it's possible independently of cross type.

10. Example:

Itiner:

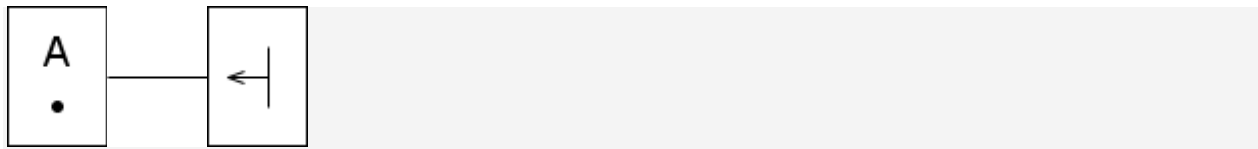

Map is:

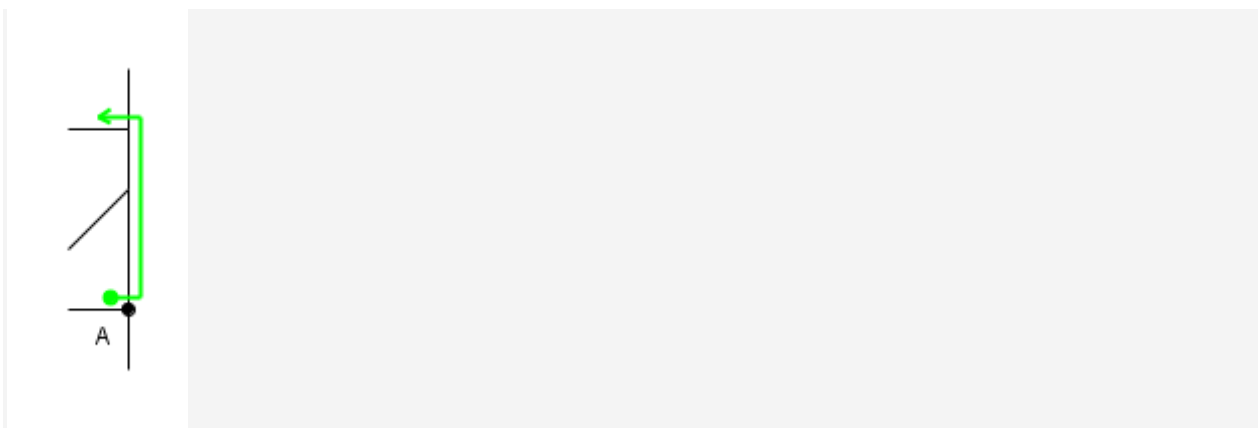

It is different from the previous example because in this case you should turn to West at a certain cross instead of turn left as it was previously. You should find the indicated cross type and leave that to West.

14.4. Objects on the map and other signs – navigation on the map from map point to map point

1. Example:

Itiner:

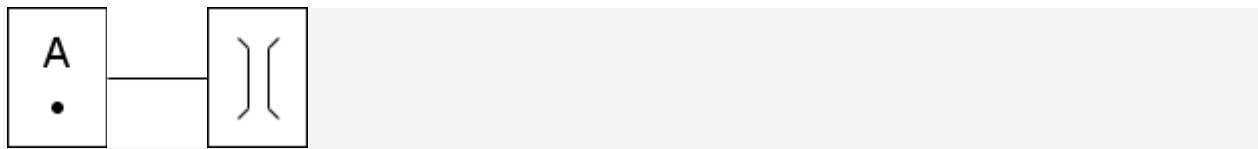

Map is:

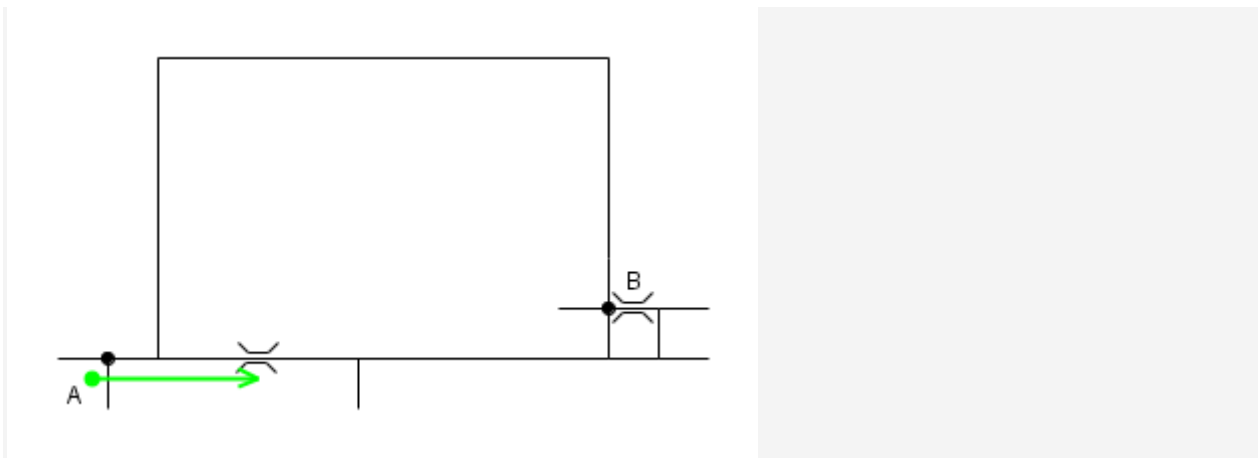

In case of map objects you should also find the nearest one but these itiner pictures are not orientated to North (crosses are orientated to North).

2. Example:

Itiner:

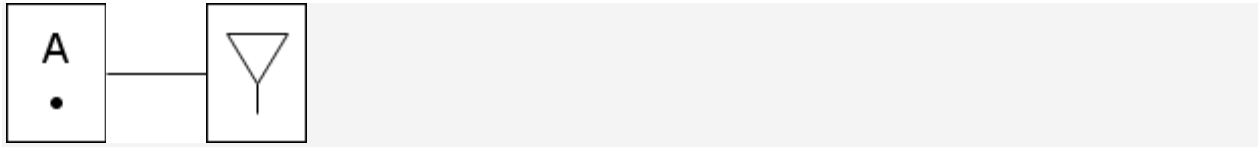

Map is:

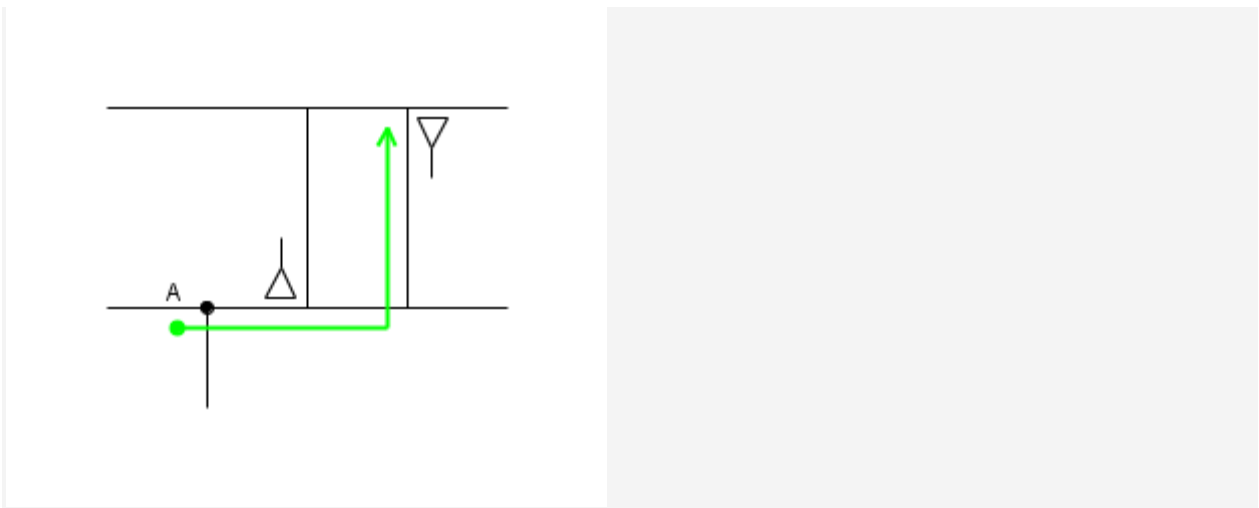

If you should find a certain road sign because of the itiner then you should pass that road sign according to standard traffic rules (road sign should be passed at the right side of the car) and you should arrive from the leg of the road sign.

3. Example:

Itiner:

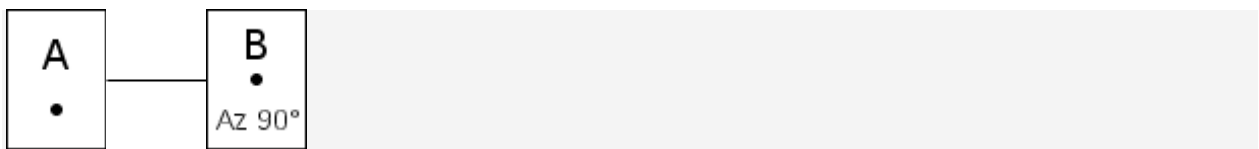

Map is:

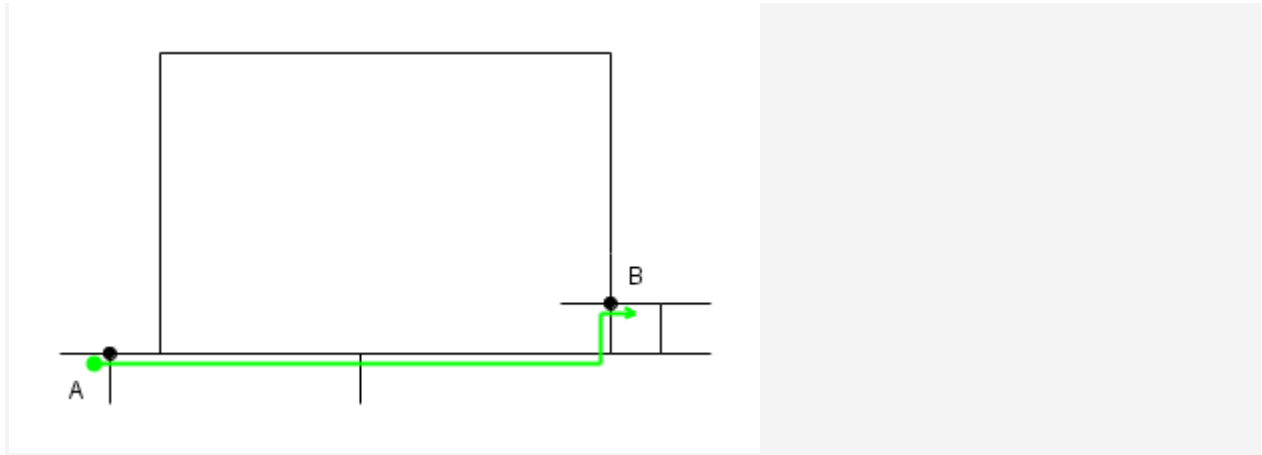

“Az XX° ” mark means Azimut it means the difference from North in degrees. In the example you should arrive to POINT B from a direction where you can leave that POINT to 90° from the North (it is East).

4. Example:

Itiner:



Map is:

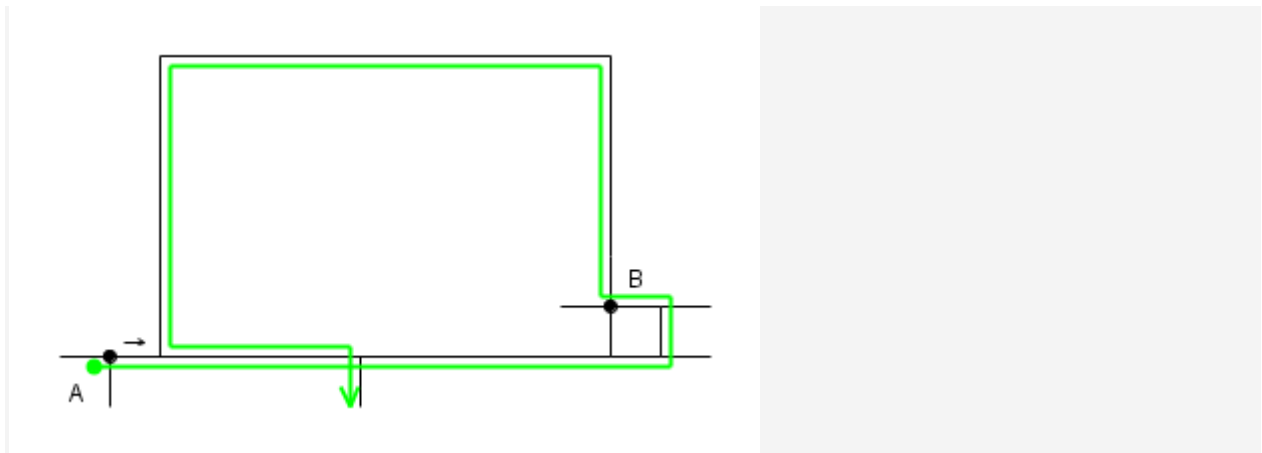

This type of itiner called “straight” itiner because the route is defined along with the central line. You should leave the marked streets according to the itiner picture, so you should keep in mind the type side of the streets (and sometimes the direction could be help as well but it’s not mandatory) but the distances between streets are not relevant. Cross means only that cross where you have possibility to choose among directions.

5. Example:

Usage of different maps:

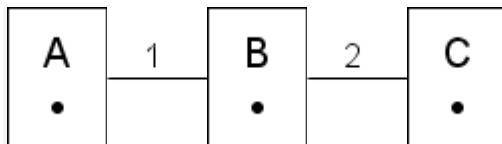

The number above the line between itiner pictures means that you should use that certain map to plan your route.

Map 1:

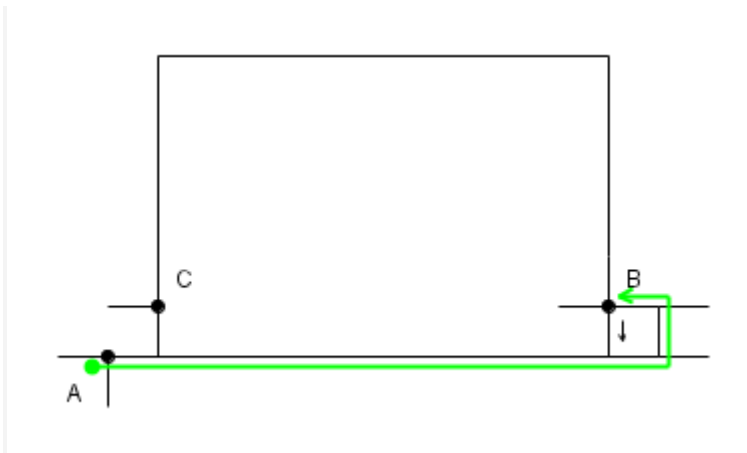

Map 2:

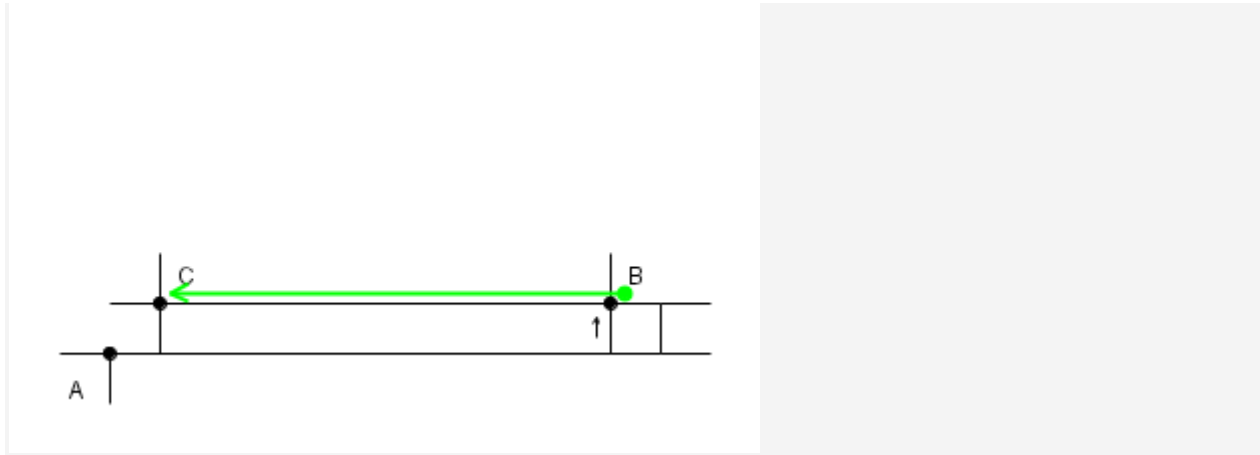

When we are planning a route on a certain map we should bypass all the information on other maps.

14.5. Re-planning of the route – navigation on the map from map point to map point

You can find examples here where you should re-plan your route on map because of real information. Itiner is the same for first six examples:

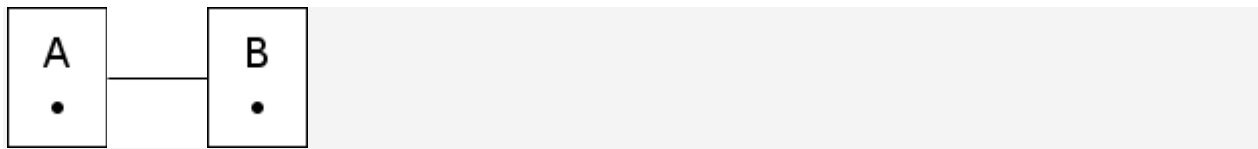

Map is also the same for first six examples:

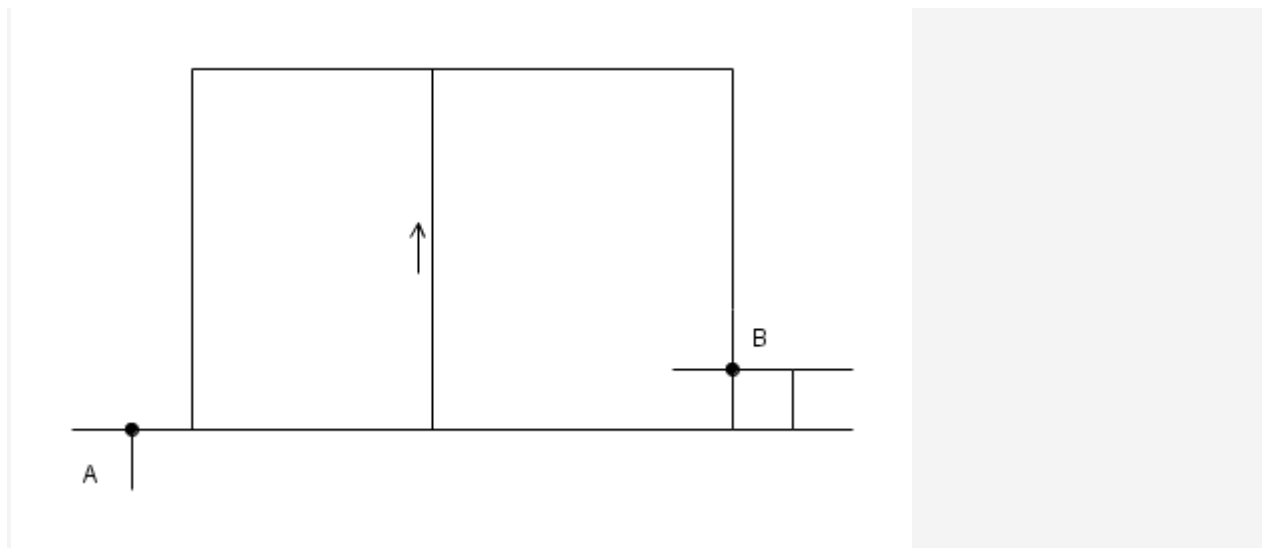

Green line means the correct route, red line means that route which planned originally.

1. Example:

Reality:

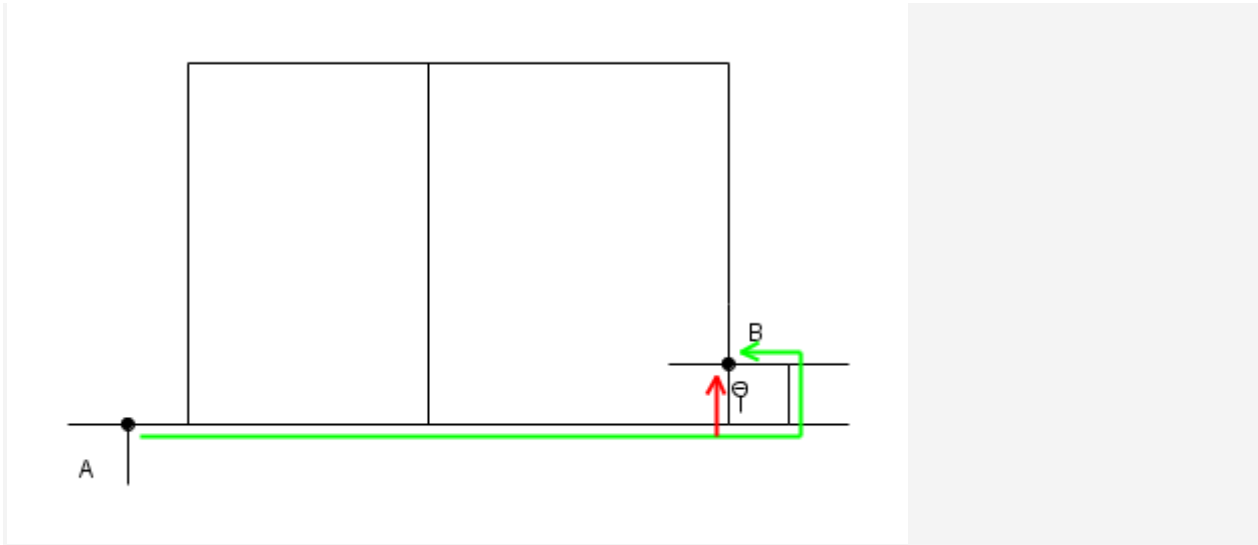

You cannot turn left where you have planned because of “no entry” road sign. The new route is straightforward from that point and arrives to POINT B from East.

2. Example:

Reality:

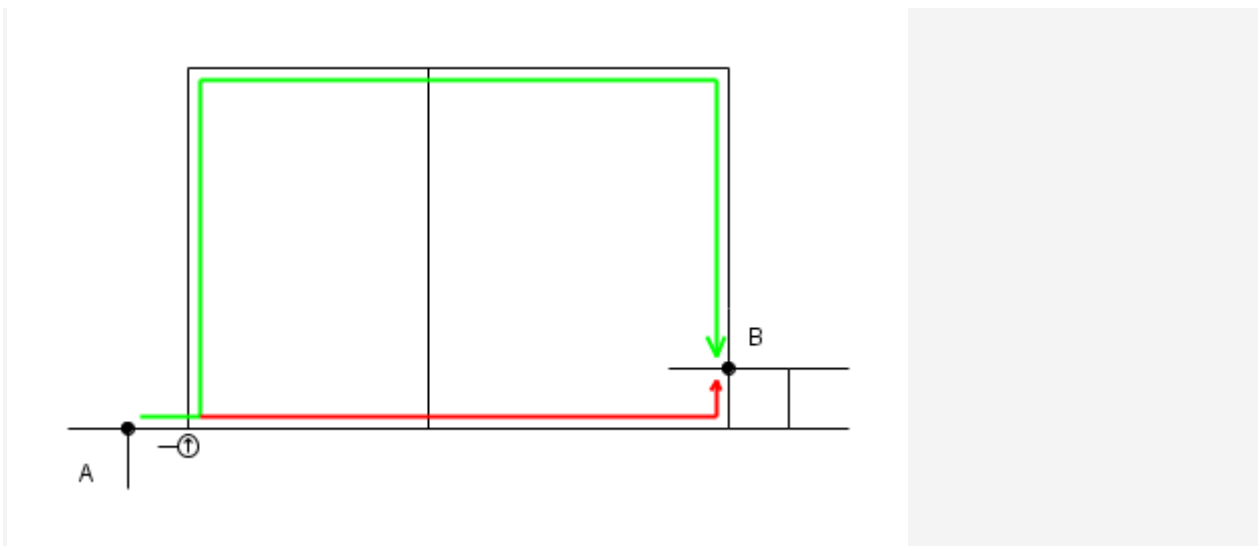

You should turn left because of “go this way - left” road sign. The new route is simple after that.

3. Example:

Reality:

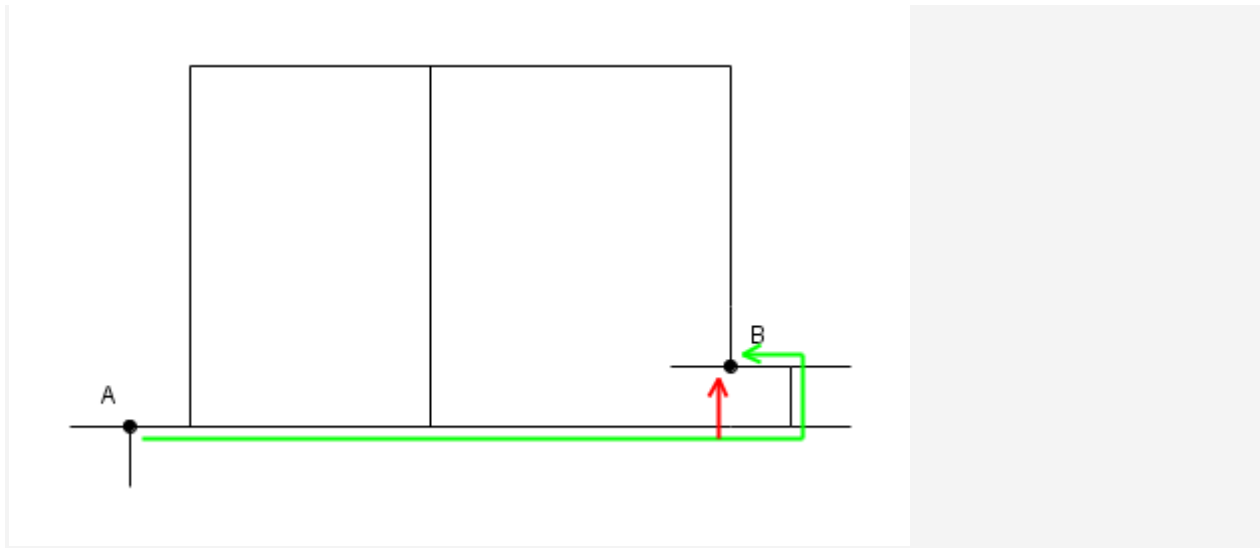

That street marked on the map is not available in the real world. It is the same situation than we would have “no entry” sign on that street.

4. Example:

Reality:

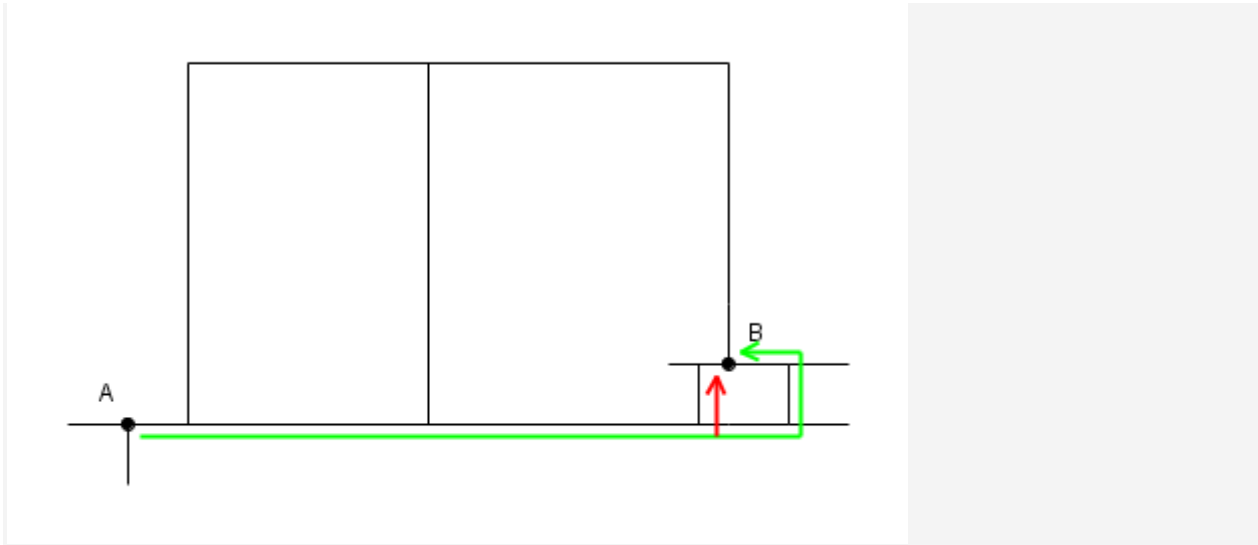

We don't have street in the real world as in the previous example. There is other street in the real world but based on the 5mm rule it is not a measurement error this should be handled as a street which is not marked on the map.

5. Example:

Reality:

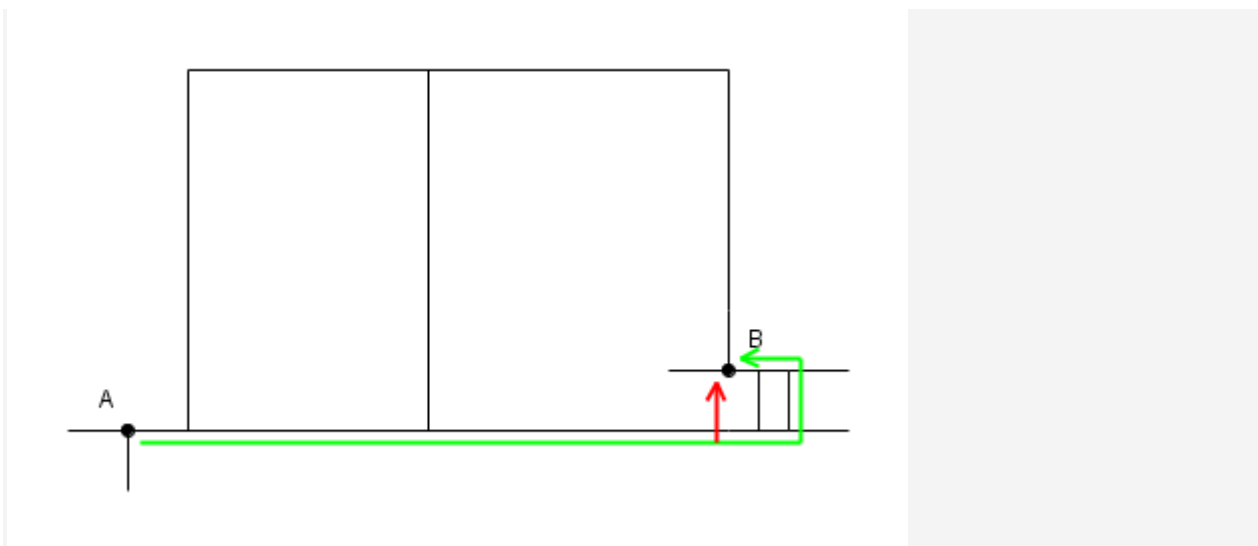

The situation is the same as before except you have that real street West from the point but if you measure that to the map the difference will be more than 5mm.

6. Example:

Reality:

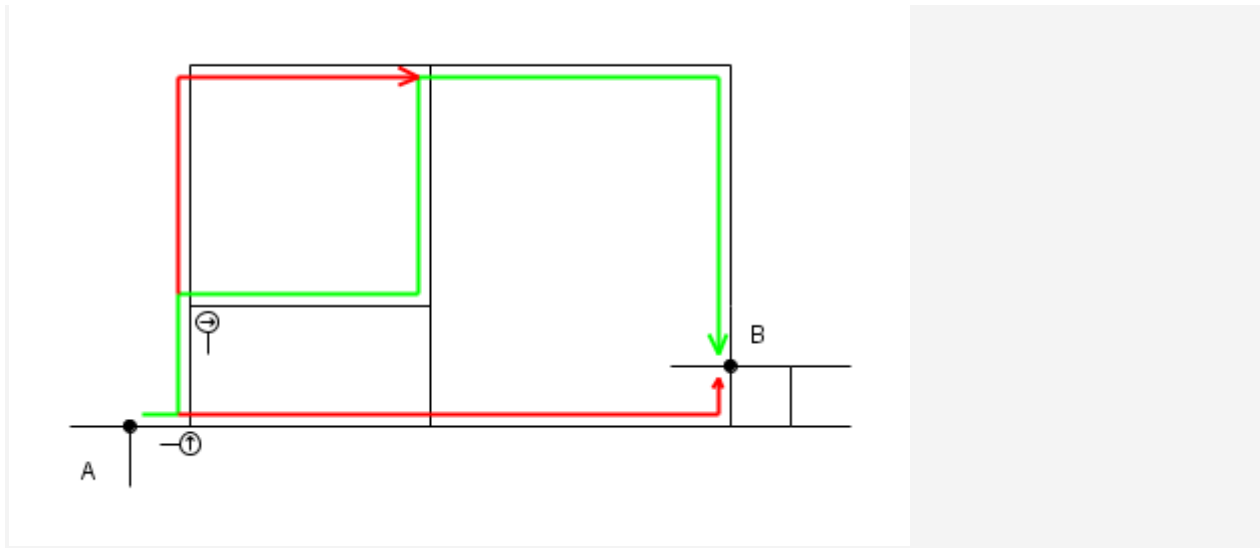

It is a more complex example: you should re-plan your route two times. During second interrupt we will leave the map and we should travel according to the navigation rules based on real information until we will be on the map again. When we will be on the map again we will be on a one way street, that's the reason why we continue our way towards North.

7. Example:

An example with new itiner and new map:

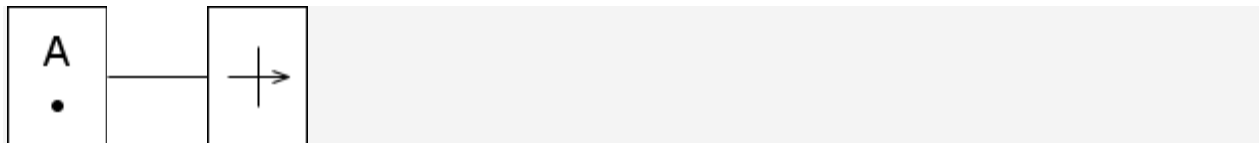

Map:

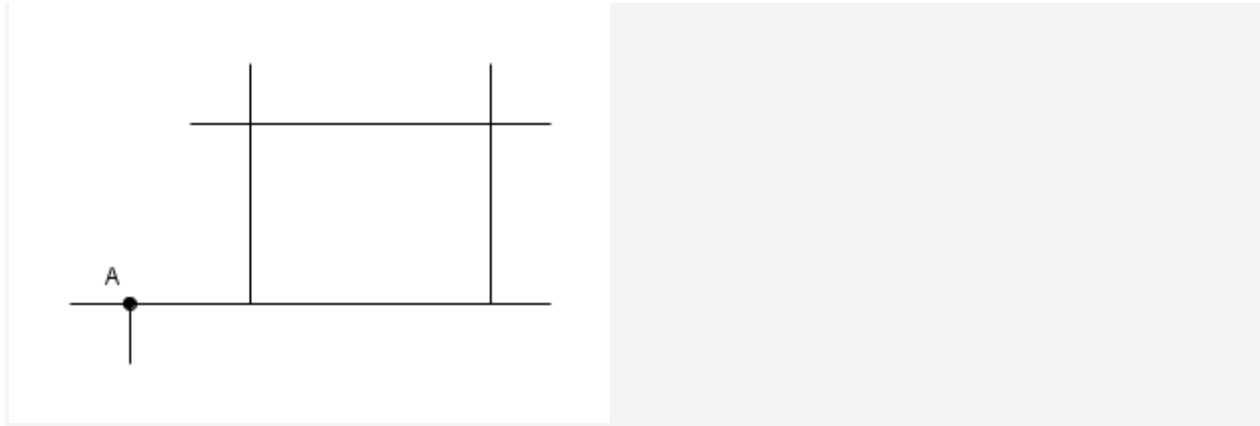

Reality:

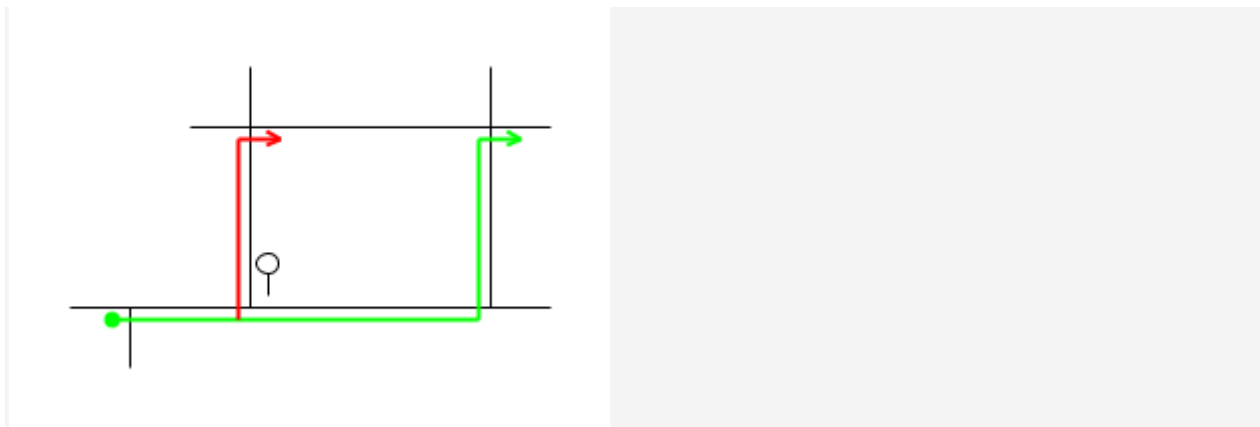

When we re-plan our route because of “no entry” sign we should find the nearest full-cross which will be different from that one what we have planned originally.

8. Example:

An example when we don't need to re-plan our route:

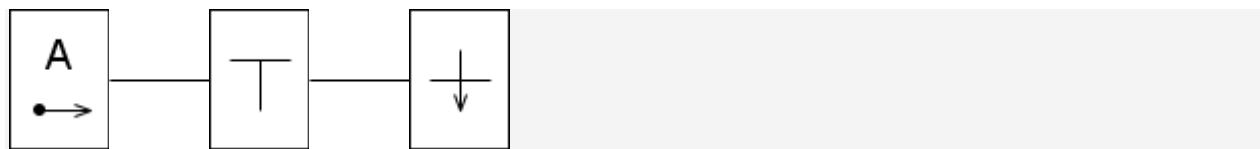

Map:



Reality:

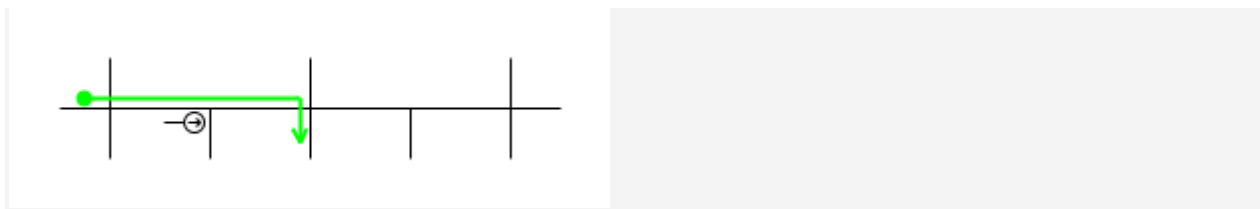

After the first cross from POINT A we can move only to East, luckily it is the same route what we have already planned, so we can keep our plan because second cross is match with second itiner picture.

14.6. Basics – navigation from real point to real point based on real information

1. Example:

Itiner:

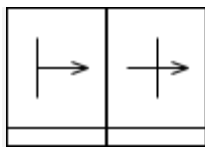

Reality:



After “turn right” we can travel according to the navigation rules based on real information until we will be able to turn right at a full-cross.

2. Example:

Itiner:

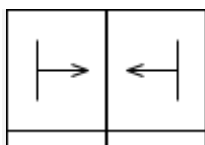

Reality:

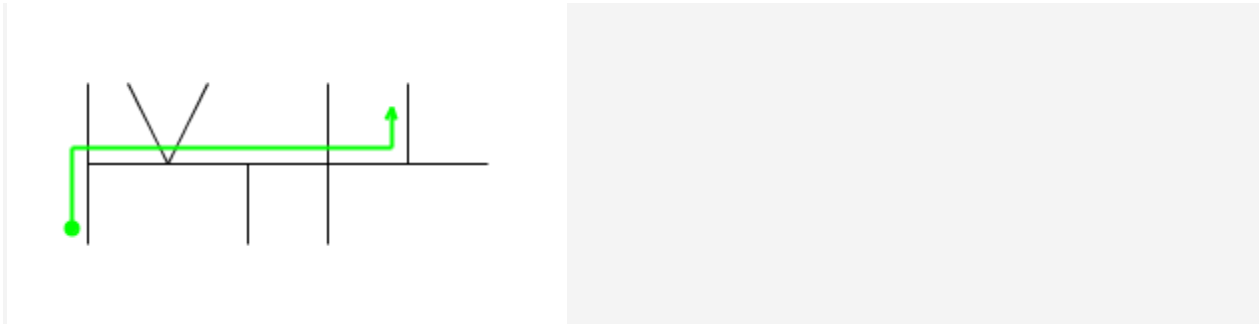

After “turn right” we can travel according to the navigation rules based on real information until we will find that certain cross type.

3. Example:

Itiner:

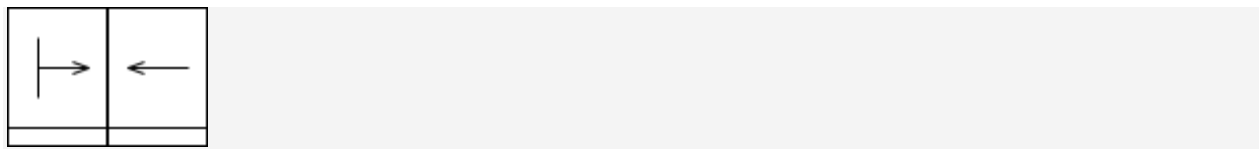

Reality:

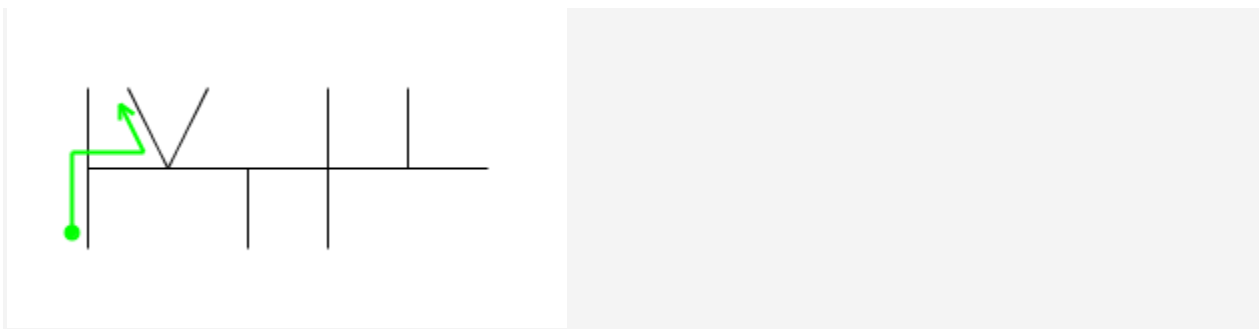

After “turn right” we can travel according to the navigation rules based on real information until we can turn left at the first possibility.

4. Example:

Itiner:

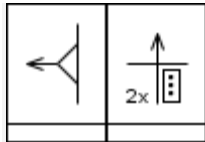

Reality:

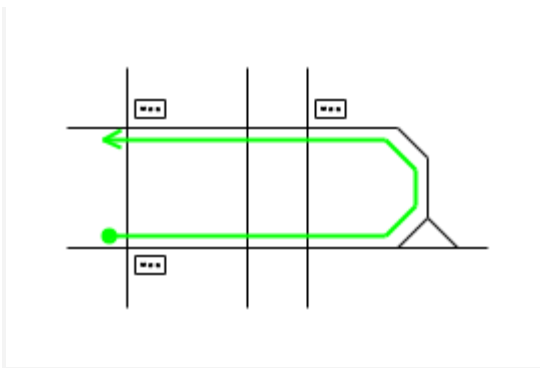

5. Example:

Itiner:

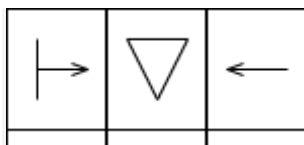

Reality:

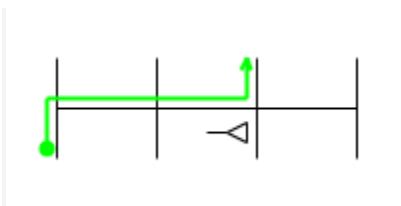

After "turn right" we can travel according to the navigation rules based on real information until we can find the first "priority sign" road sign and we can turn left at the road sign.

6. Example:

Itiner:

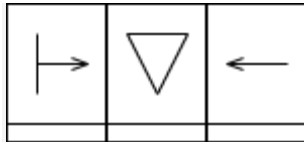

Reality:

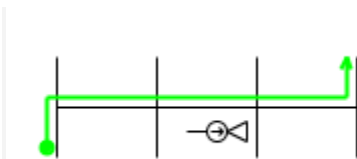

We would like to emphasize that we should turn left after the “priority sign” road sign where we have cross with at least two choices.

7. Example:

*When we should turn left at certain road sign then the short version of itiner pictures described in 5.
Example is:*

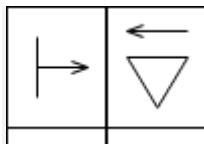

Reality:

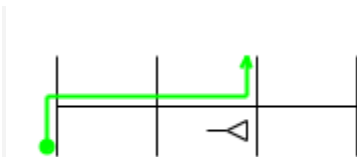

8. Example:

We have different sign for certain road sign or for road signs in general.

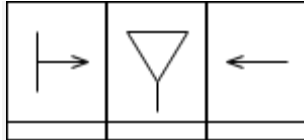

Reality:

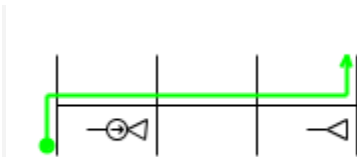



When we have driven until a certain road sign then it is marked with leg on the itiner and you should find exactly the same road sign what we have on the itiner (without complementary sign). If you have road sign without leg in the itiner then you should find a road sign which valid for you but should have complementary sign as well.

are three real itiner pictures. First we should pass a street from left after that we should travel 200m according to the navigation rules based on real information (straightforward on the picture) and after that at the full-cross we should turn left.

4. Example:

Itiner:

		
0,0	0,2	0,3

Reality:

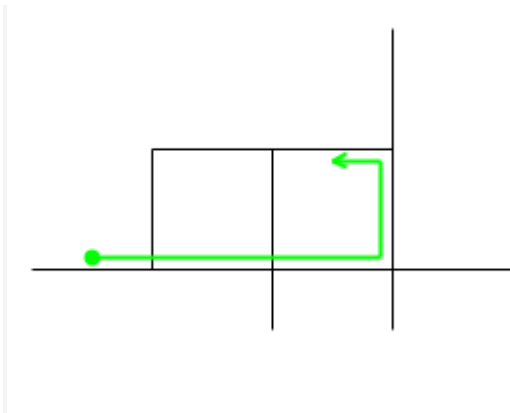

In this example the numbers are representing the distance from the first itiner picture not between the itiner pictures.

14.8. Navigation on the map from real point to map point

1. Example:

Map:

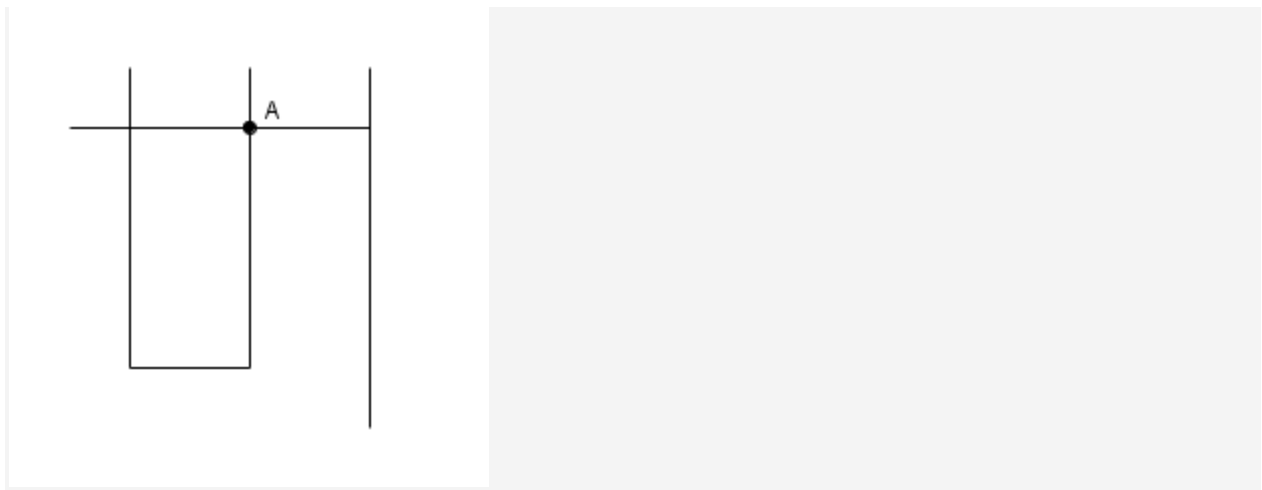

Itiner:

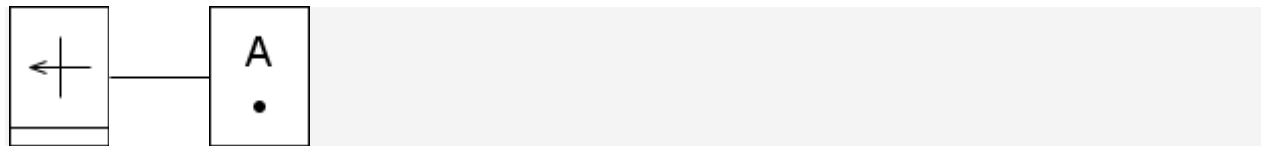

Reality:

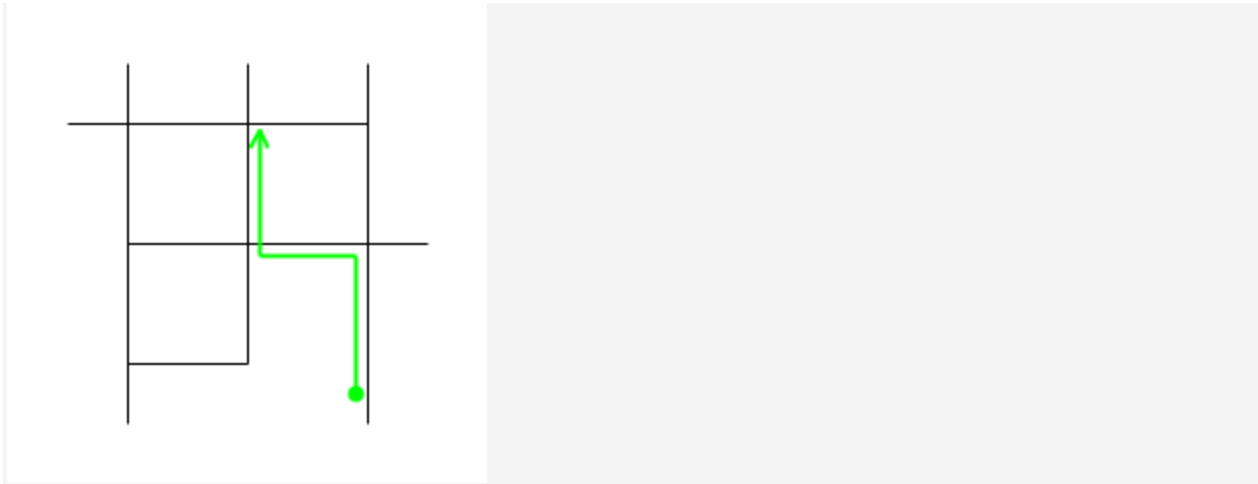

We turn left at the full-cross and we will leave the map. After that we travel according to the navigation rules based on real information until we will be on the map again. When we have arrived back to the map we should find the nearest route to POINT A.

2. Example:

Map:

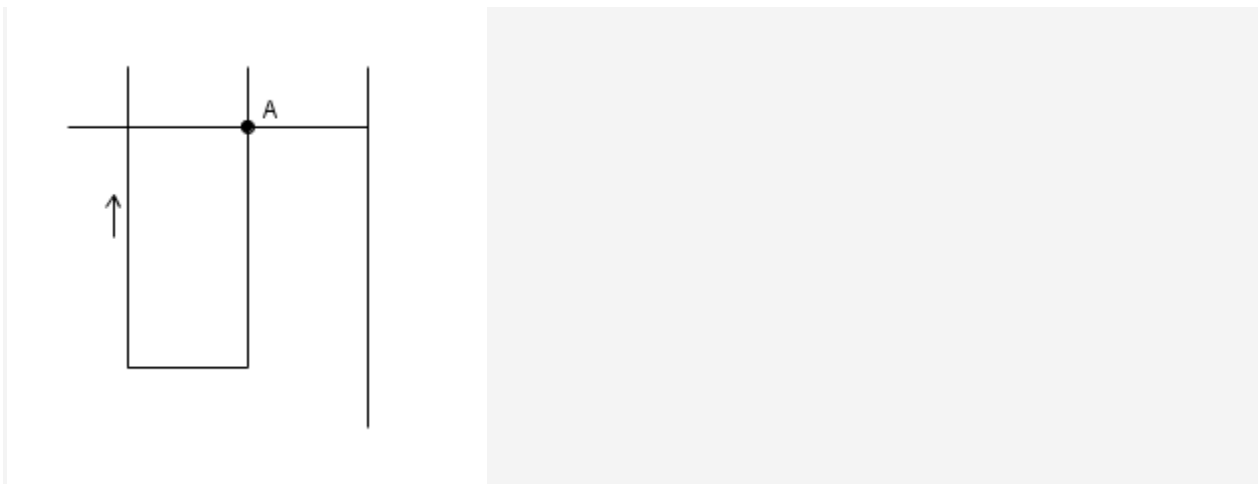

3. Example:

Map:

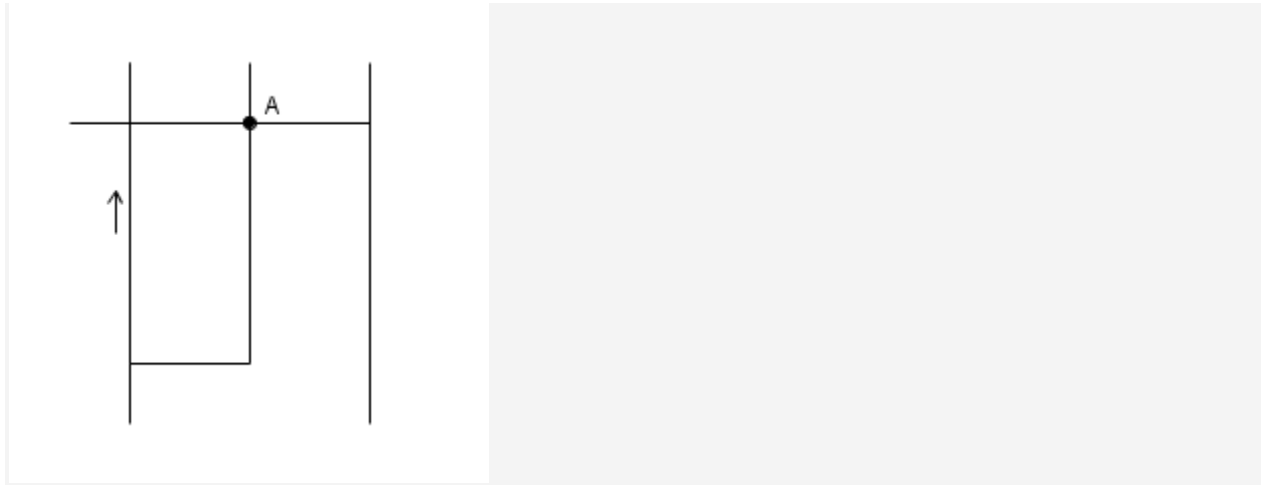

Itiner:

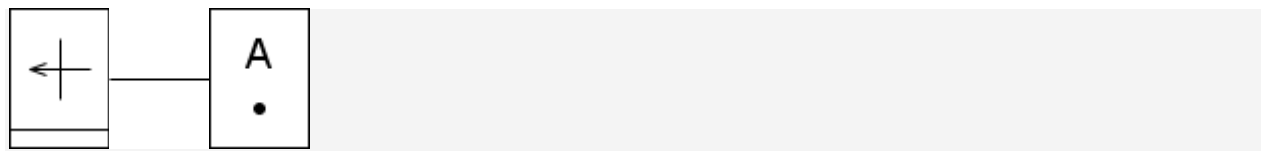

Reality:

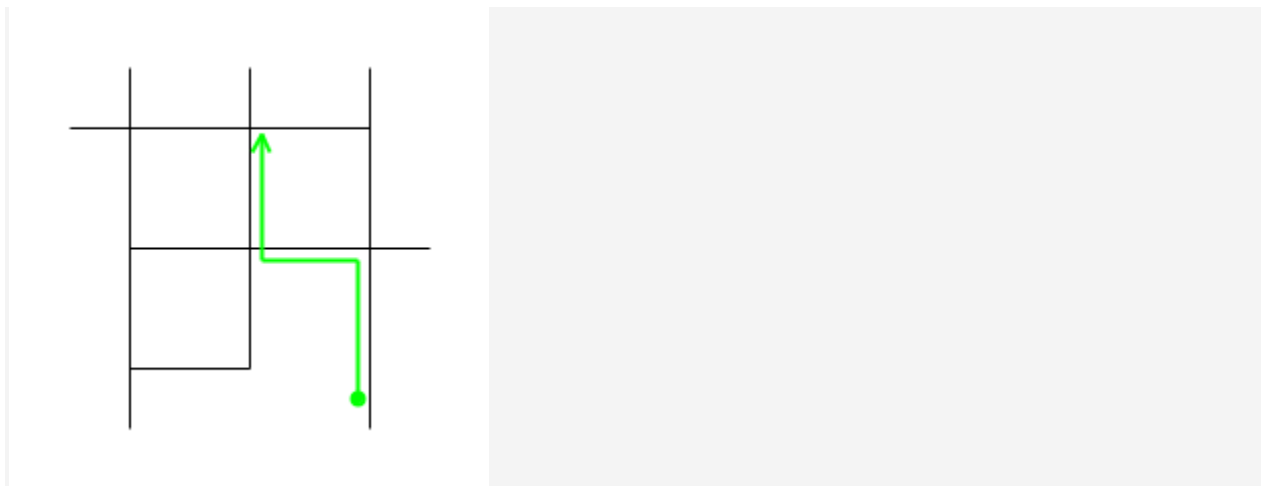

We have a different map again. One way arrow valid only between two crosses, so because of “stick” towards South we will arrive to a street which is not a one way street and we can turn to North.

14.9. Navigation based on real information from real point to map point

1. Example:

Map:

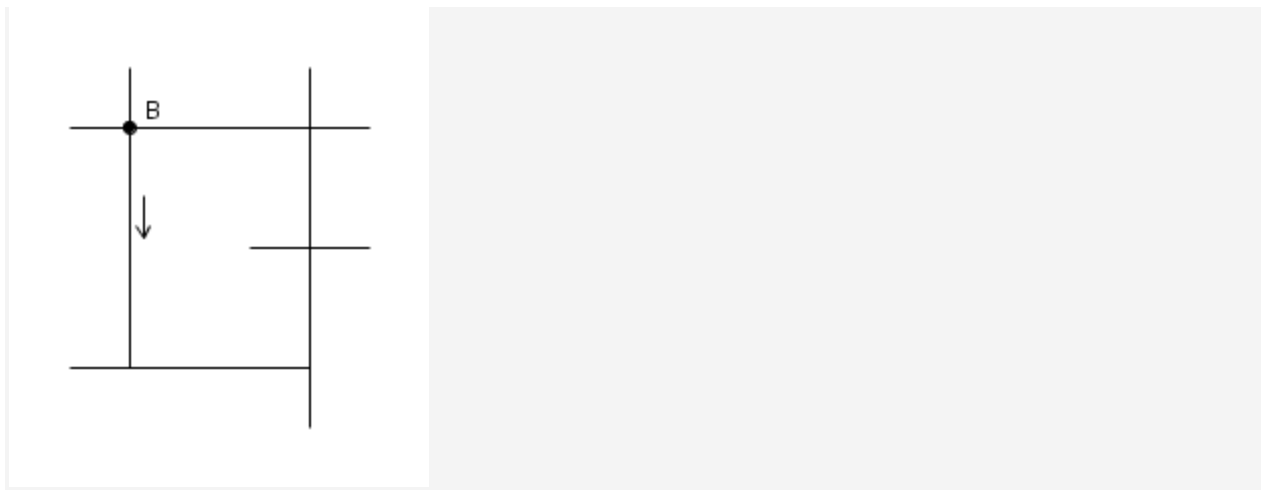

Itiner:

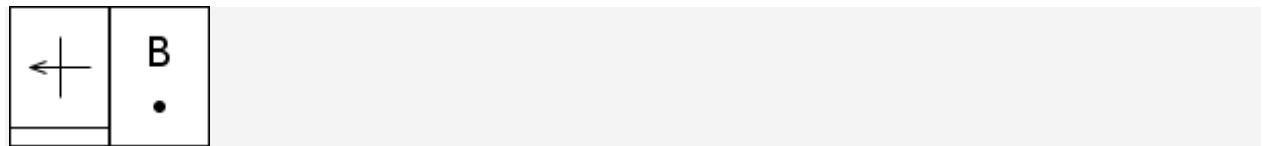

14.10. Navigation based on real information from map point to map point

1. Example:

Map:

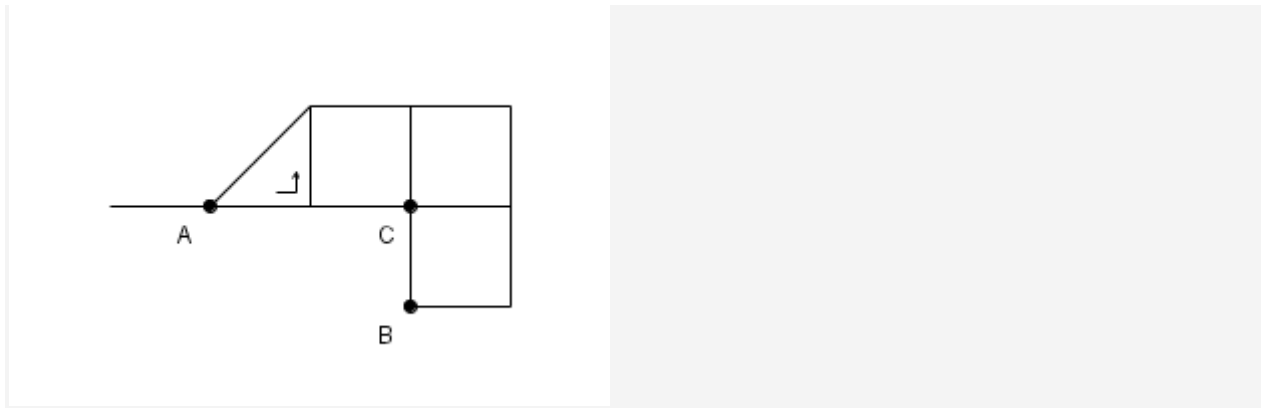

Itiner:

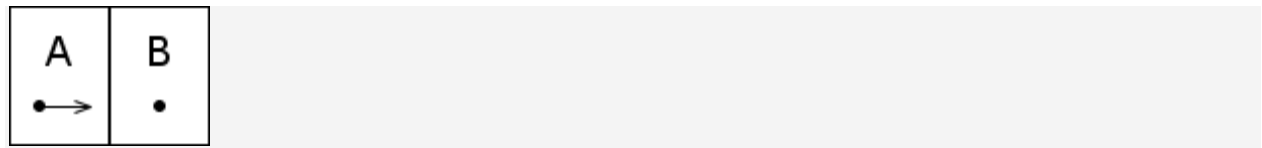

Reality:

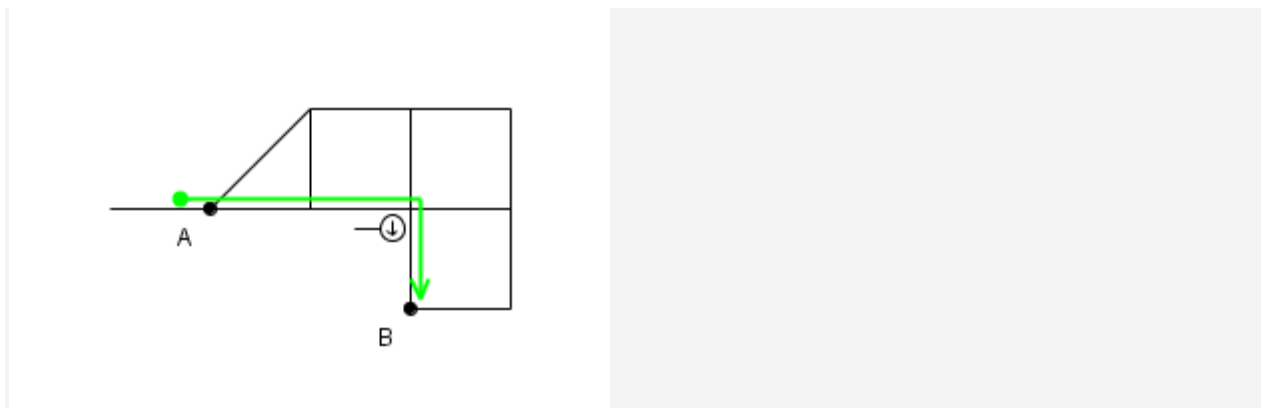



We are travelling from POINT A according to the navigation rules based on real information, so those information which marked on the map doesn't matter for us (e.g. turning arrow and POINT C) until we have arrive to POINT B. But proposed to check where we are travelling on the map during navigation based on real information to know when we will be in POINT B.

14.11. Navigation based on real information from map point to real point

All the examples have the same map:

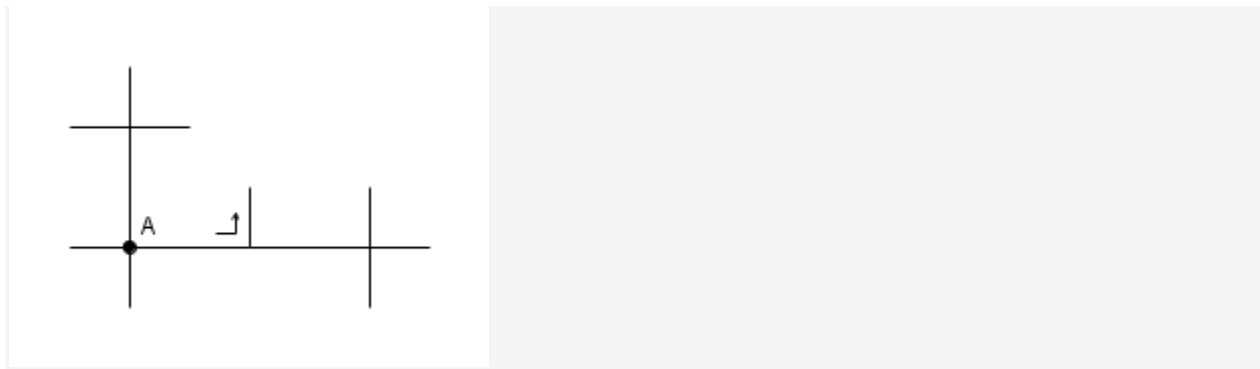

1. Example:

Itiner:

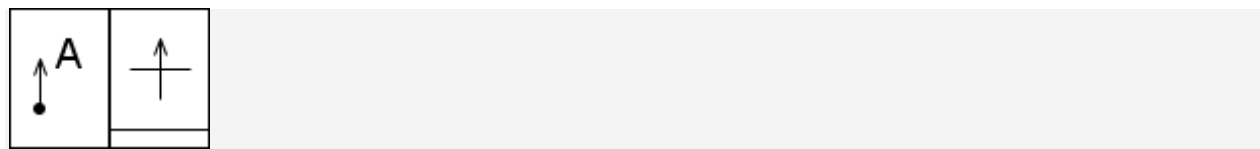

Reality:

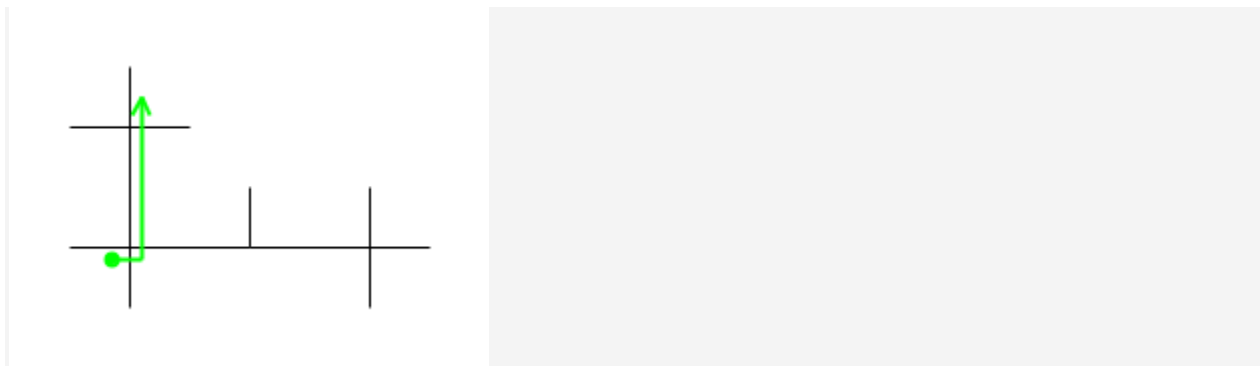

We leave POINT A to North. From there we travel according to the navigation rules based on real information until we find a full-cross.

2. Example:

Itiner:

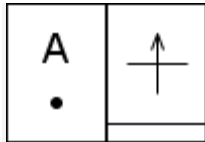

Reality:

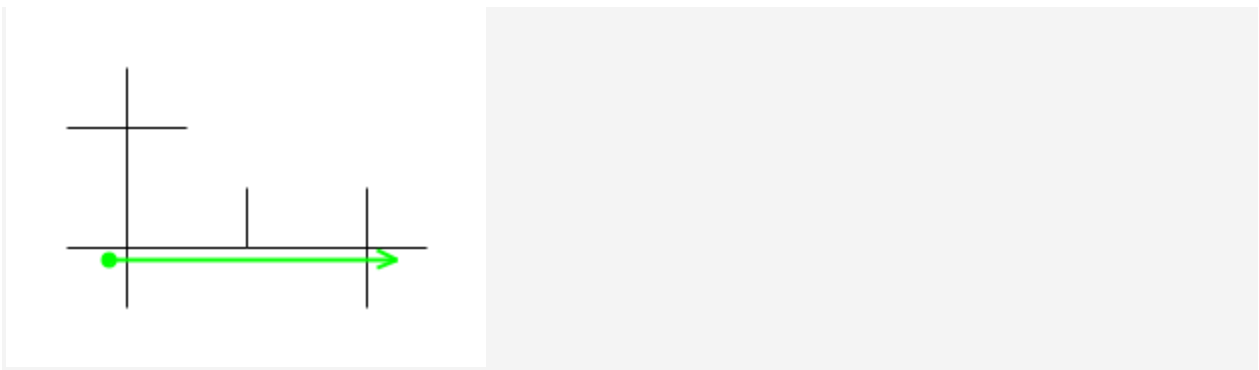

We leave POINT A according to the navigation rules based on real information, so to straightforward. From there we don't check the map just travel until we find a full-cross.

3. Example:

Itiner:

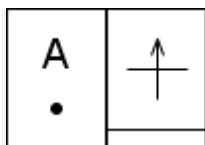

Reality:

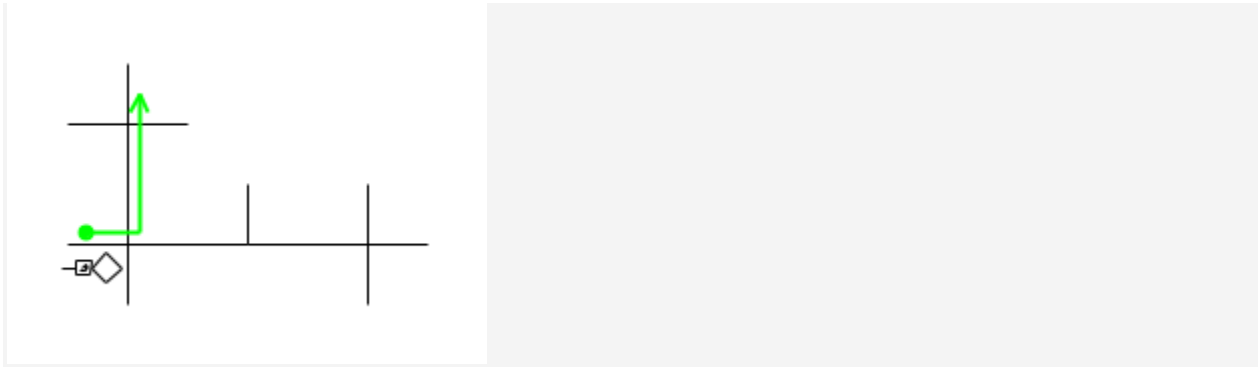

Because of “major road” road sign we should leave POINT A according to navigation rules based on real information, so we will go north.

4. Example:

Itiner:

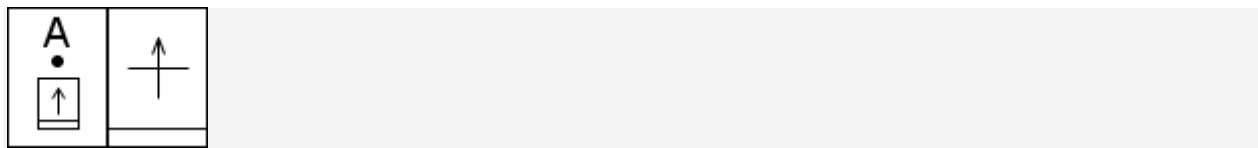

Reality:

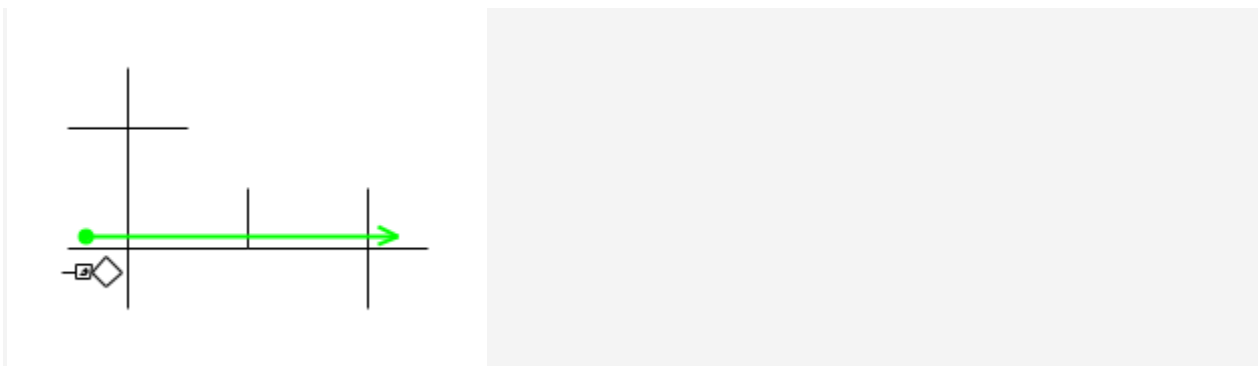

At the POINT A we should go real “straightforward”, so we will pass that cross to East. After that we should travel according to navigation rules based on real information until we will arrive to a full-cross.

14.12. DETAIL

1. Example:

Map:

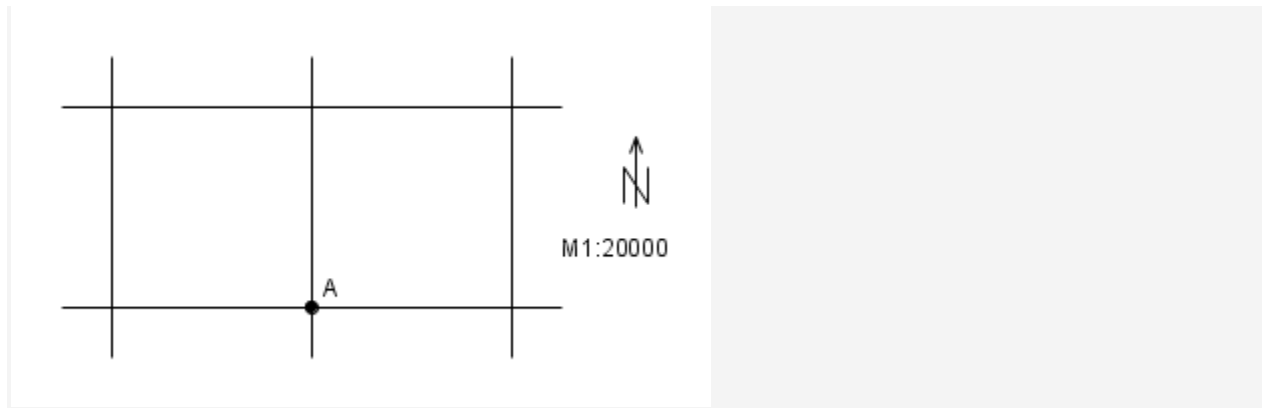

DETAIL:

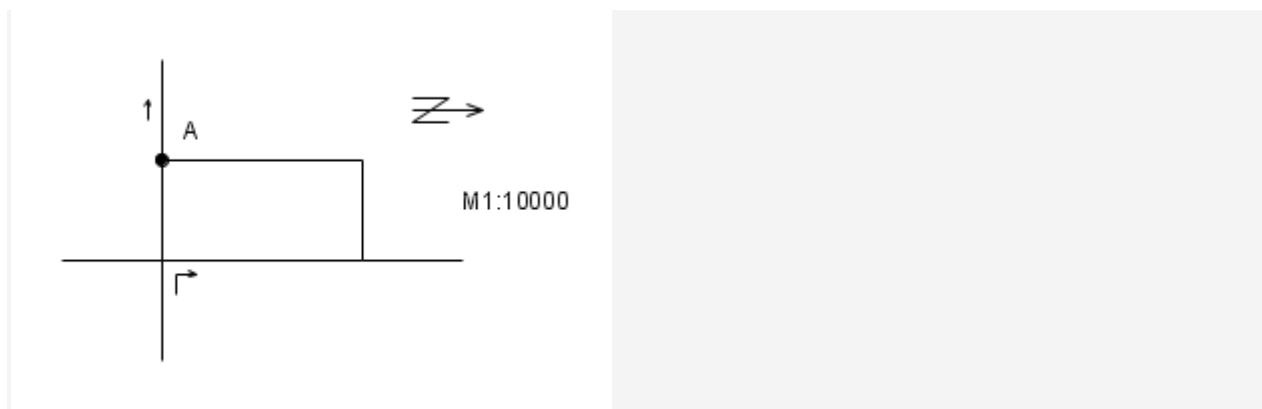

Both of those:

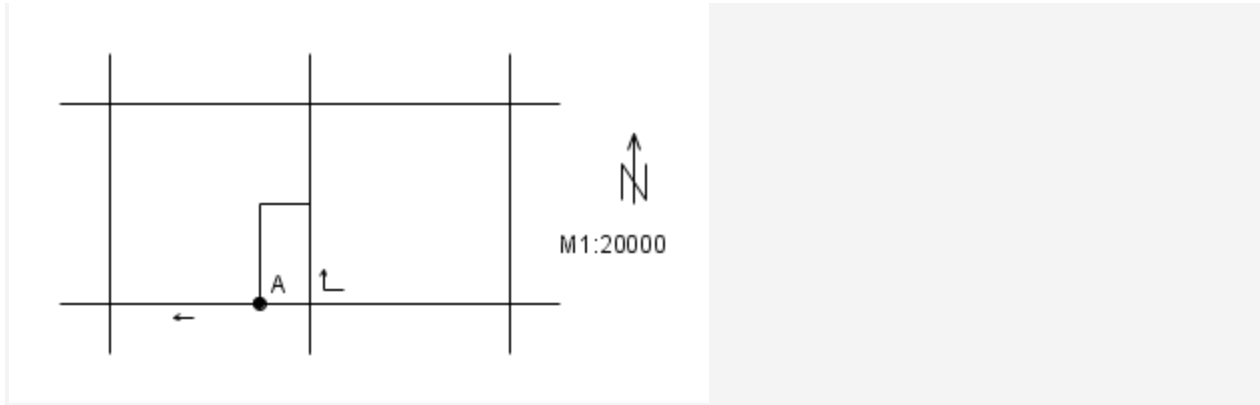

In this example you have different scale and compass between MAP and DETAIL. DETAIL is defining POINT A more precisely. DETAIL is also put a turning arrow and one way arrow into the map.

14.13. CONSTANT

1. Example:

CONSTANT:

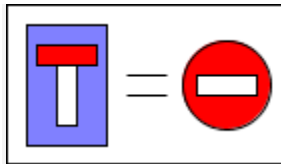

Itiner:

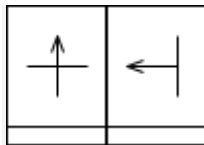

Reality:

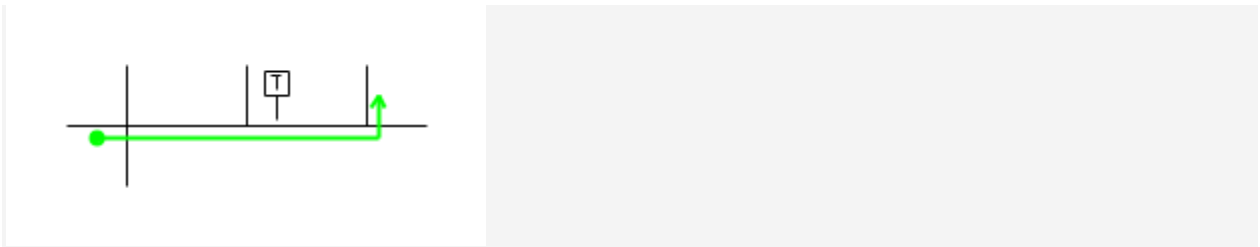

Based on CONSTANT information “dead end” means “no entry”, so we don’t need to turn left at the first cross.

14.14. CONDITION

1. Example:

Itiner:

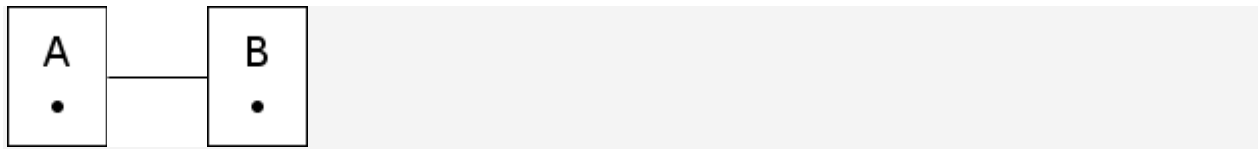

CONDITION:

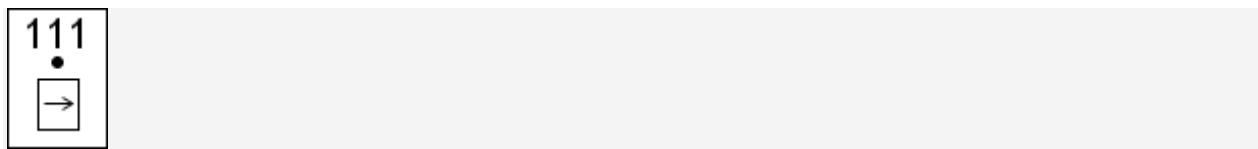

Map:

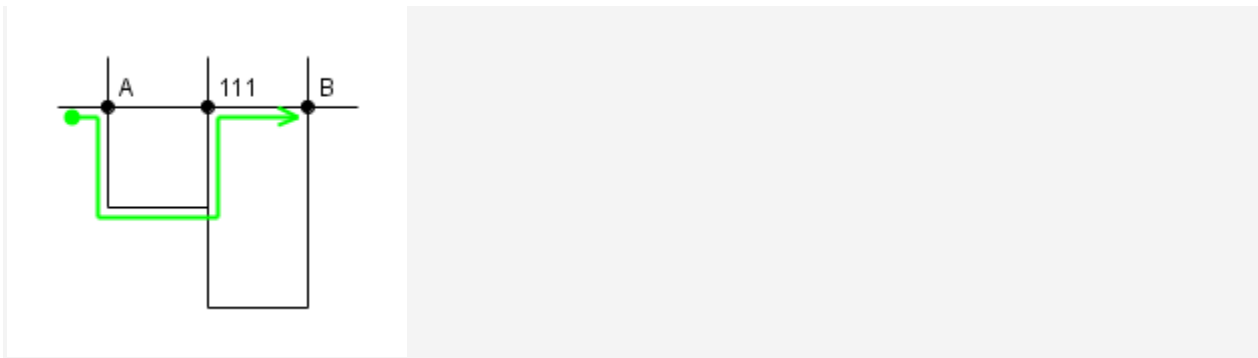

Based on CONDITION we should turn right on the map at POINT 111, so when we are planning the route to POINT B we should plan with CONDITION as well and shortest way will be if we arrive from South to POINT 111 drive according to CONDITION and arrive to POINT B from West.

2. Example:

Itiner:

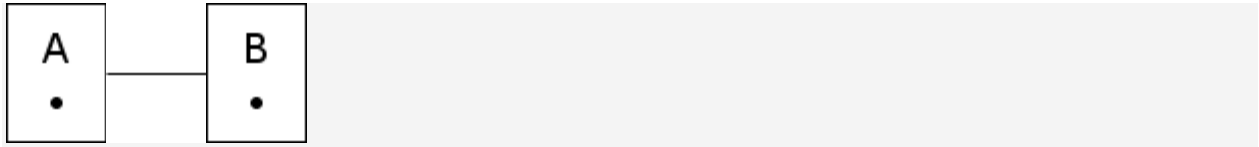

CONDITION:

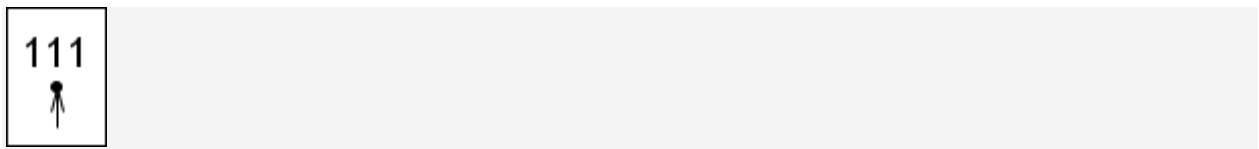

Map:

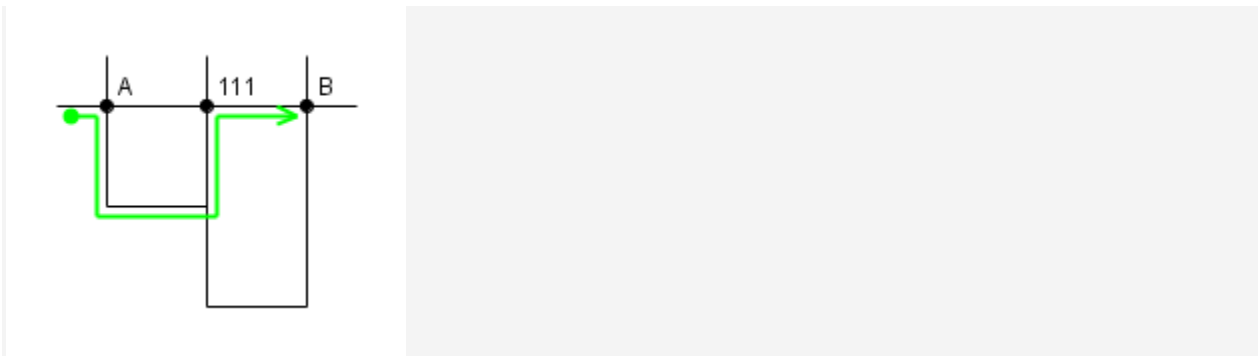

We should arrive to POINT 111 only from South.

3. Example:

Itiner:

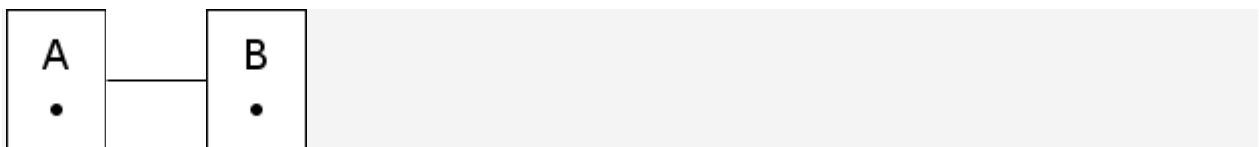

CONDITION:

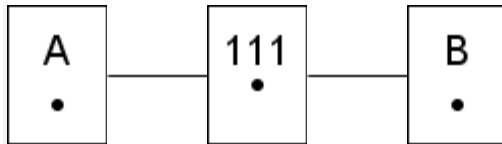

Map:

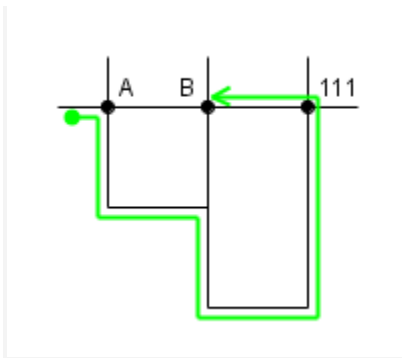

Based on *CONDITION* we should reach *POINT 111* when we are planning our route between *POINT A* and *POINT B*.

4. Example:

Itiner:

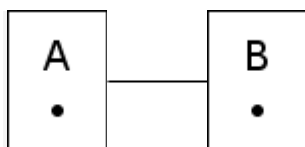

CONDITION:

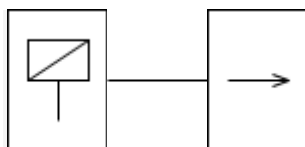

Map:

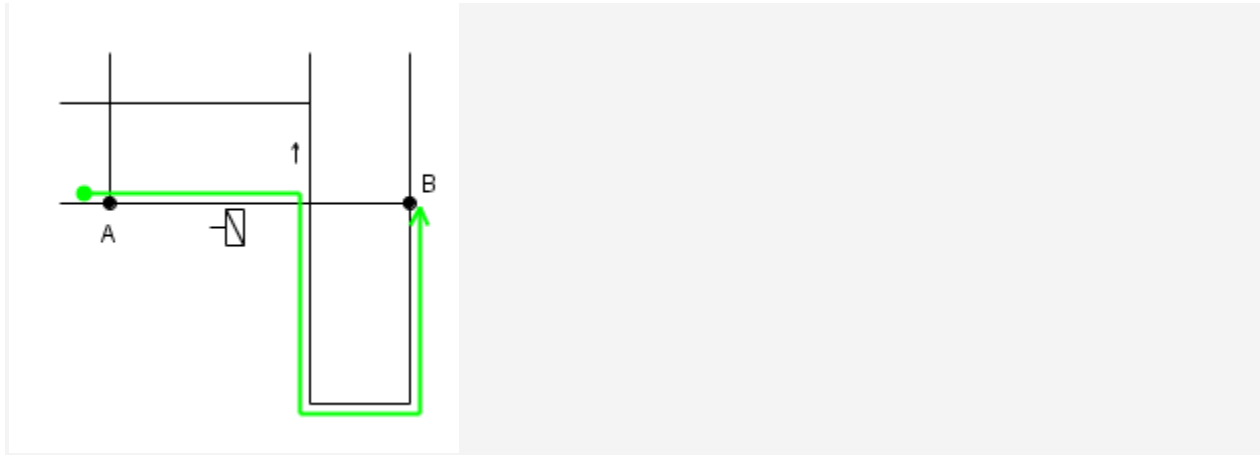

We should start our route from POINT A to POINT B only to East because no any other way. So, we should pass next to the mentioned road sign and after that based on CONDITION we should find the nearest right turn on the map. After we have turned to South at the cross we should find the shortest way to POINT B which is quite simple now.

5. Example:

Itiner:

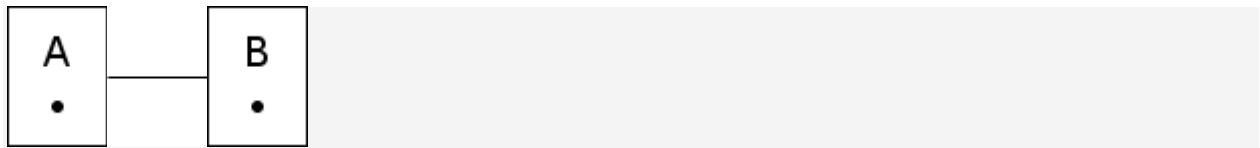

CONDITION:

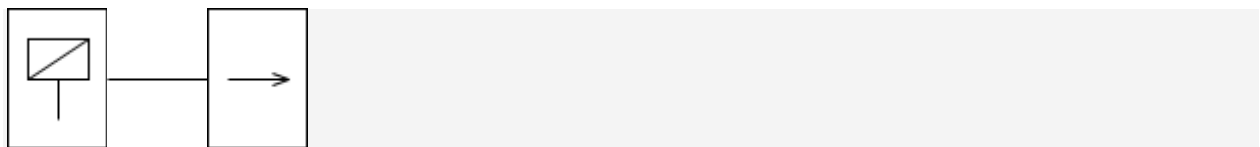

Map:

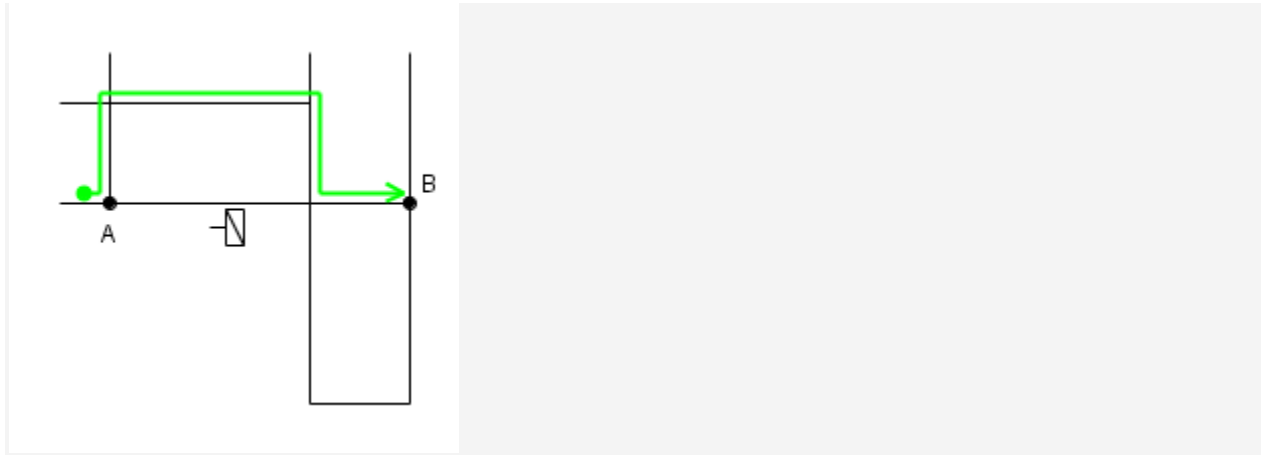

That street which was one way street on the previous map it is a normal street now. If we plan our route from POINT A to East then we will get “town is over” road sign and we will turn right on the map at the next cross. But if we plan a route from POINT A to North then we will get shorter route then in the previous case.

6. Example:

Itiner:

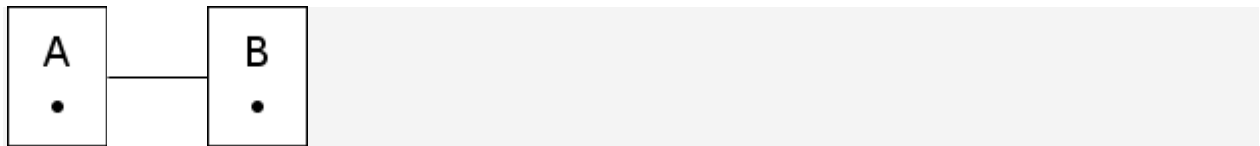

CONDITION:

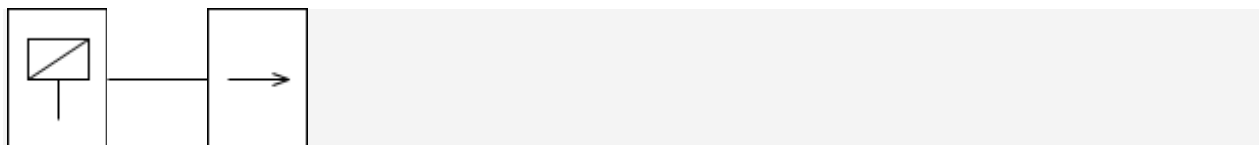

Map:

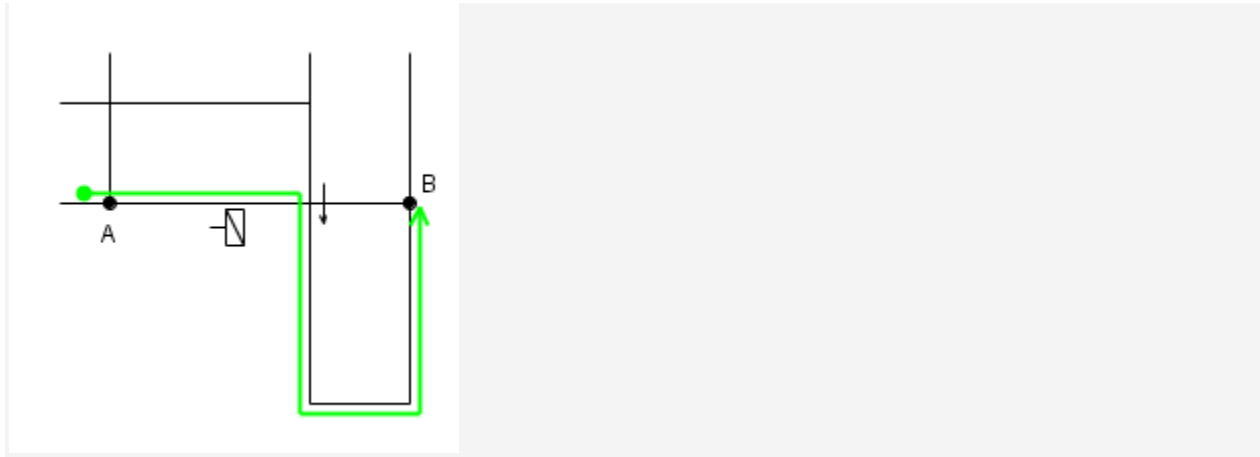

Now, we have a turning arrow on the map, so if we would like to use that route which was correct at the previous example then we will get longer route, so now we should leave POINT A to East for the shortest route.

14.15. INSERT

1. Example:

Itiner:

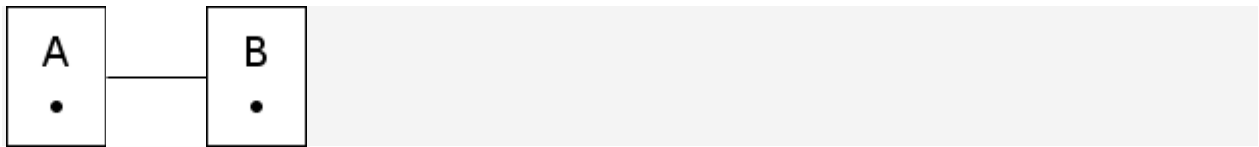

INSERT:

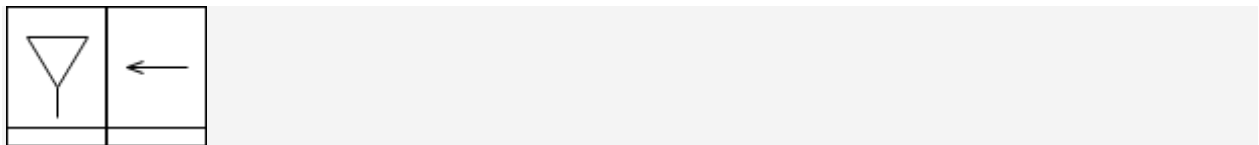

Reality:

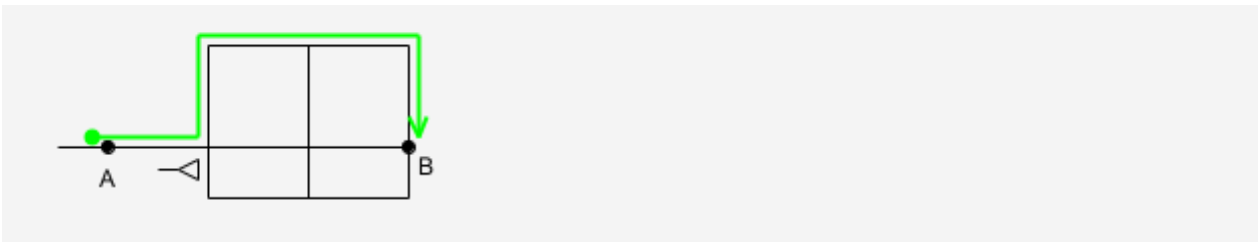

You should turn left at the cross where the sign is located because of Insert.

2. Example:

Itiner:

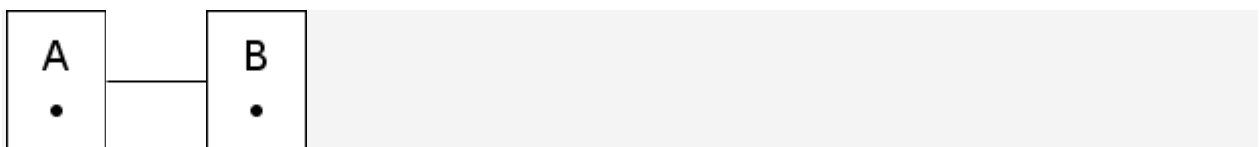

INSERT:

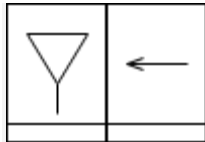

Reality:

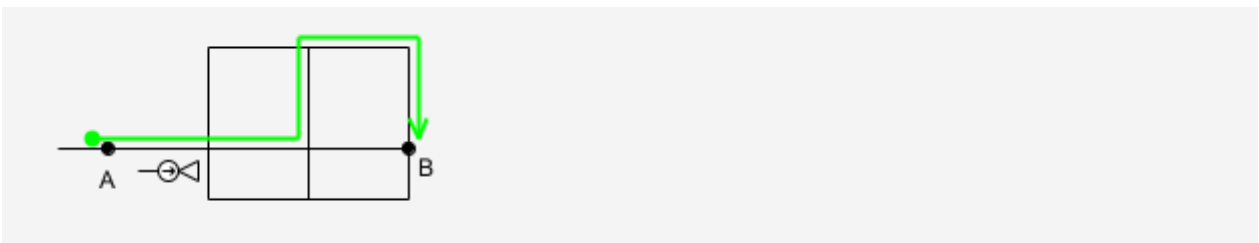

You cannot turn left at the cross where the sign is located because of complementary straight sign but you can do this at the next cross, so you should do there because Insert is still valid.

3. Example:

Itiner:

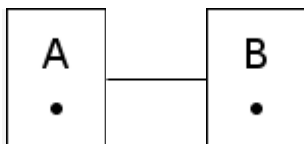

INSERT:

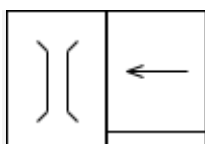

MAP:

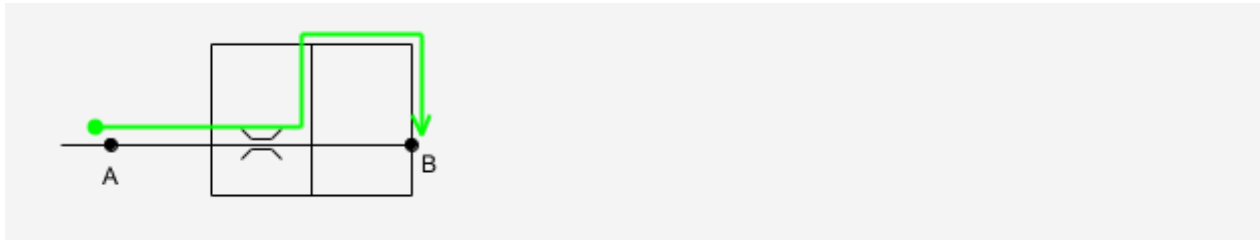

You can get the Insert at the bridge and you can turn left at the first possibility. You can see the differences from Condition here because you are not calculating with Insert before you will be at the bridge.

4. Example:

Itiner:

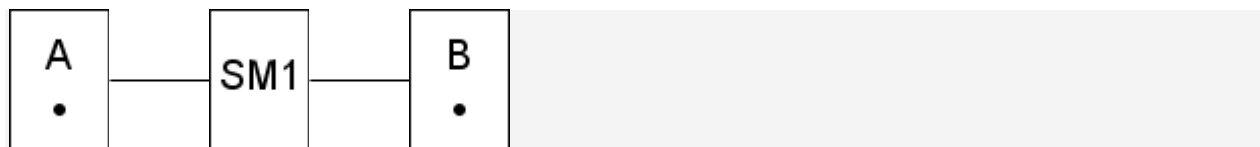

INSERT:

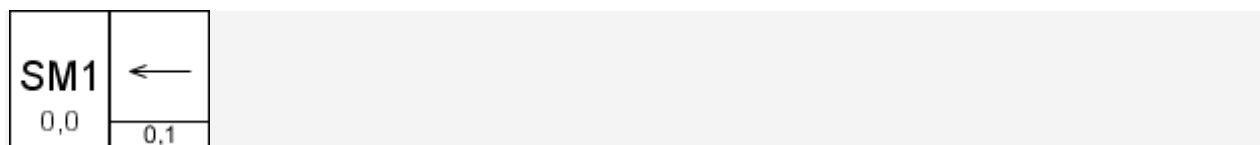

SM1:

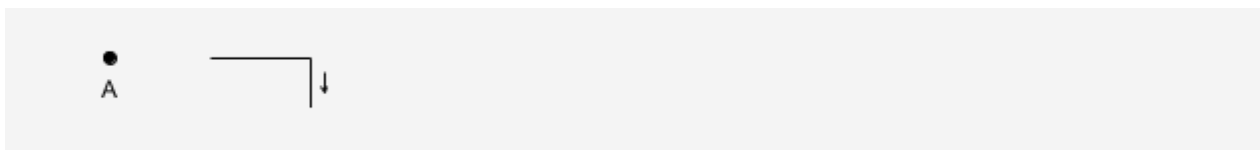

MAP:

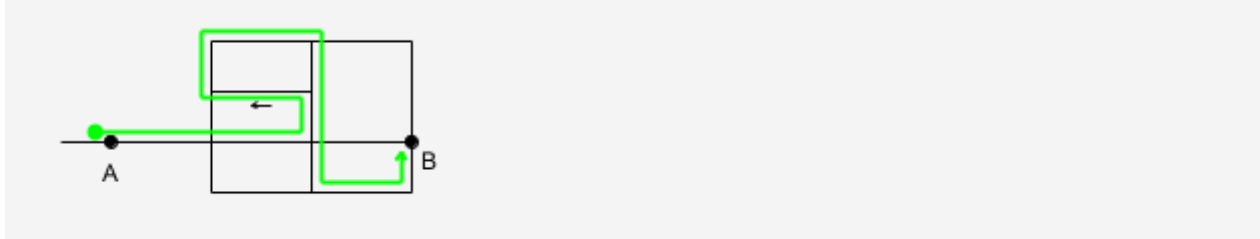

You should turn left when you are travelling on SM and reach 100m.

14.16. SM

1. Example:

Itiner:

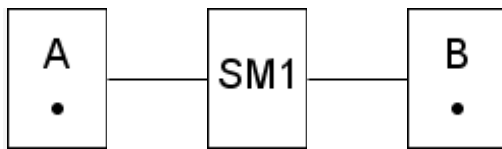

Map:

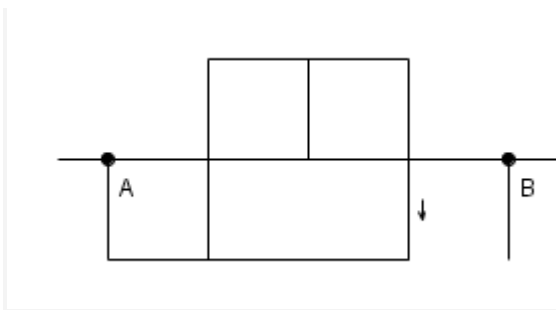

SM1:

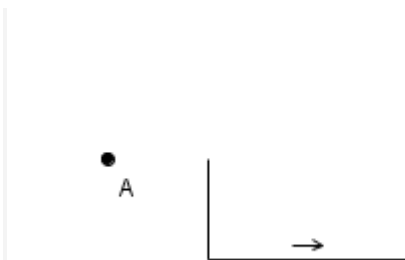

Correct route:

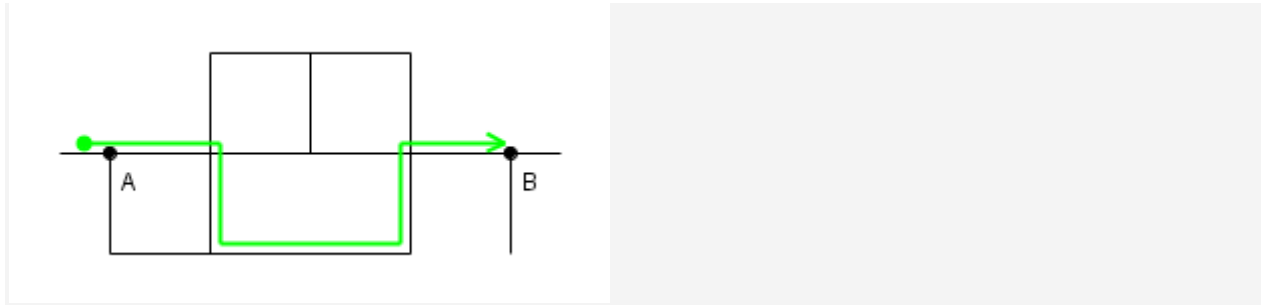

After we have passed POINT A we should plan a route on the map to the starting point of SM1. From that point we should go through on SM1 bypass all the information on the map (bypass the one way arrow). After SM1 we should navigate according to the map again to the shortest route to POINT B.

2. Example:

Itiner:

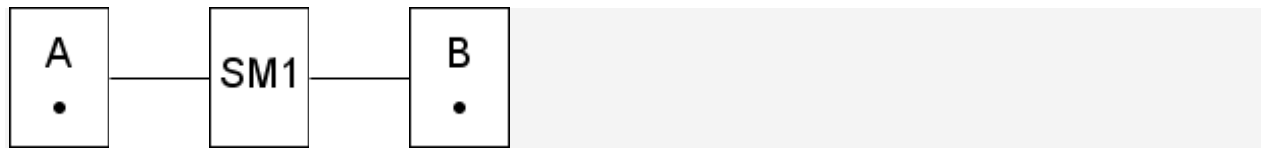

Map:

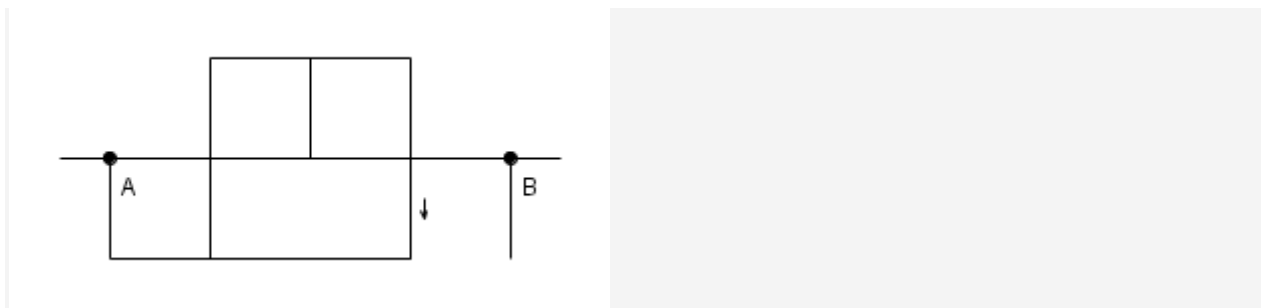

Map:

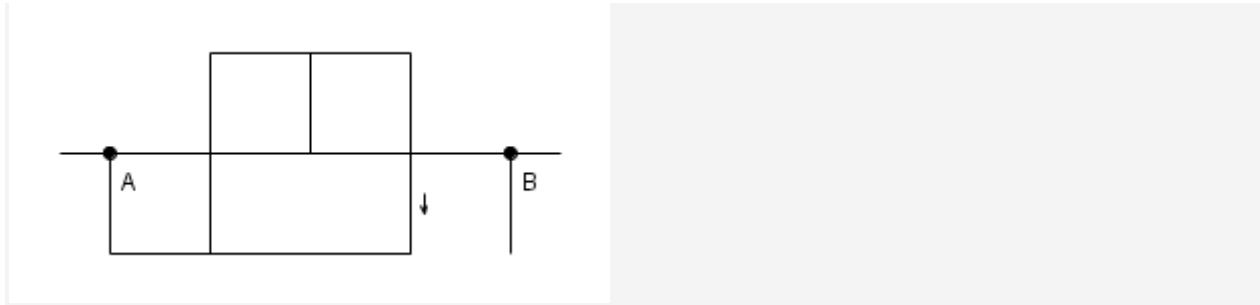

SM1:

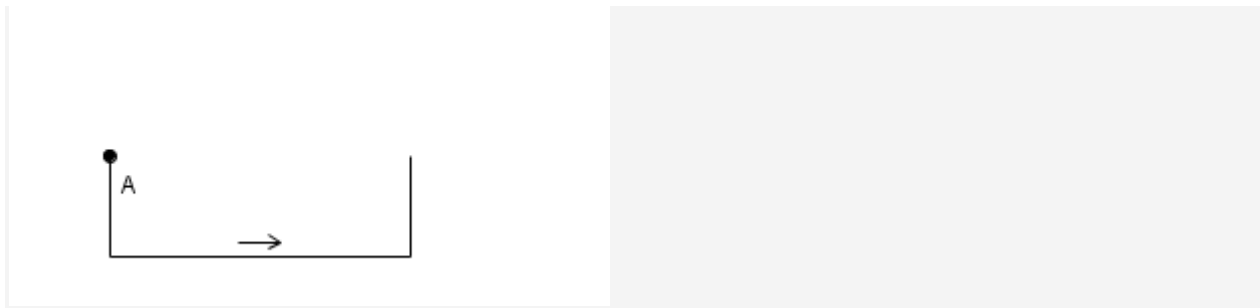

Correct route:

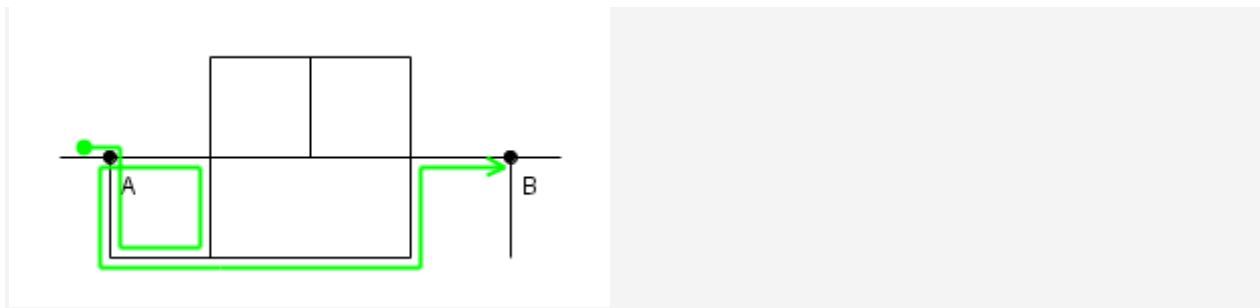

We should turn around in the square (it is similar when we should plan a route from a map POINT to the same map POINT again) to start SM1. We should realize that we cannot use turning order because if we would like to turning in that square from the opposite direction then we won't be able to start SM1.

4. Example:

It is a more complex example where we should interrupt SM1:

Itiner:

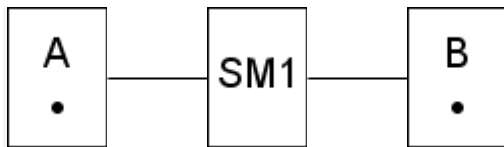

Map (Base Map):

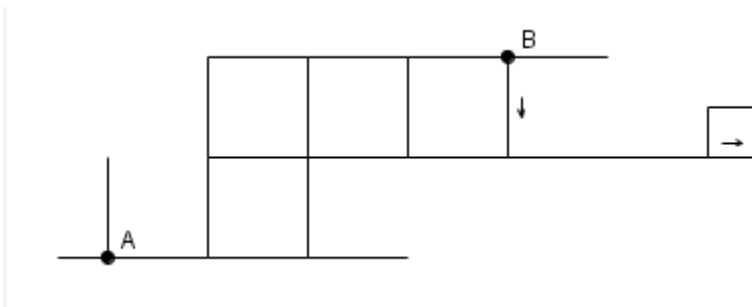

SM1:

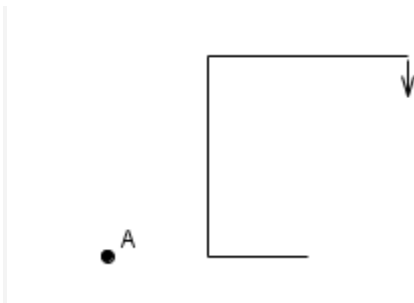

Reality:

